

TechBook



Y series™

whatever the spa, this is your control system

Total Flexibility
Total Compatibility
Total Satisfaction





Table of contents

Warnings 2

Introduction 3

Features 4

in.ye overview: 5

in.ye dimensions: 5

in.yt overview: 6

in.yt dimensions: 6

in.k200 dimensions: 7

Y Series installation

in.k200 installation & connections

- Installing the in.k200 9
- Connecting the main keypad to the spa pack 9

Y Series connections

- Electrical wiring for North American model of the Y Series 10
- Electrical wiring for North American or CE model of the Y Series 10
- Heater connections 12

Power-up & breaker setting 13

Programming the Y Series 14

Low-level configuration selection charts 15

Y Series field programming options 18

- High voltage accessory connections 21

In.k200 keypad overview

- Function description 26
- Instructions 26
- Typical settings 28

Y Series error codes

- Y Series error codes summary 29
- Hr error message / flow chart & step-by-step 30
- Prr error message / flow chart & step-by-step 30
- HL error message / flow chart & step-by-step 31
- FLO & UPL error message / flow chart & step-by-step 33
- OH error message / flow chart & step-by-step 34

Troubleshooting

- Pump 1 doesn't work / flow chart & step-by-step 35
- Pump 2 or blower doesn't work / flow chart & step-by-step 37
- Circulation pump doesn't work / flow chart & step-by-step 39
- Ozonator doesn't work / flow chart & step-by-step 40
- Nothing seems to work / flow chart & step-by-step 41
- Nothing seems to work / flow chart & step-by-step 42
- Spa not heating / flow chart & step-by-step 44
- Keypad doesn't seem to work step-by-step 45

GFCI trips 45

Step-by-step field replacement procedure 46

How to replace the heater 49

How to replace main control board on in.ye 50

How to replace the main control board on in.yt 51

How to replace the upper extension board on the in.yt 52

Specifications 53



Warnings



WARNINGS:

Before installing or connecting the unit, please read the following.

- * FOR UNITS FOR USE IN OTHER THAN SINGLE-FAMILY DWELLINGS, A CLEARLY LABELED EMERGENCY SWITCH SHALL BE PROVIDED AS PART OF THE INSTALLATION. THE SWITCH SHALL BE READILY ACCESSIBLE TO THE OCCUPANTS AND SHALL BE INSTALLED AT LEAST 5' (1.52 M) AWAY, ADJACENT TO, AND WITHIN SIGHT OF THE UNIT.
- * ANY DAMAGED CABLE MUST BE IMMEDIATELY REPLACED.
- * TURN POWER OFF BEFORE SERVICING OR MODIFYING ANY CABLE CONNECTIONS IN THIS UNIT.
- * TO PREVENT ELECTRIC SHOCK HAZARD AND/OR WATER DAMAGE TO THIS CONTROL, ALL UNUSED BUSHING CONDUITS MUST BE PLUGGED WITH THE ATTACHED NIPPLE.
- * THIS CONTROLLER MUST NOT BE INSTALLED IN PROXIMITY OF HIGHLY FLAMMABLE MATERIALS.
- * LOW SUPPLY VOLTAGE OR IMPROPER WIRING MAY CAUSE DAMAGE TO THIS CONTROL SYSTEM. READ AND FOLLOW ALL WIRING INSTRUCTIONS WHEN CONNECTING TO POWER SUPPLY.
- * THIS PACK CONTAINS NO USER SERVICEABLE PARTS. CONTACT AN AUTHORIZED SERVICE CENTER FOR SERVICE.
- * ALL CONNECTIONS MUST BE MADE BY A QUALIFIED ELECTRICIAN IN ACCORDANCE WITH THE NATIONAL ELECTRICAL CODE AND ANY STATE, PROVINCE OR LOCAL ELECTRICAL CODE IN EFFECT AT THE TIME OF THE INSTALLATION.

Aeware®, Gecko®, and their respective logos are Registered Trademarks of Gecko Alliance Group. In.yt™, in.ye™, in.keys™, in.touch™, in.k200™, in.flo™, in.put™, in.seal™, in.link™, in.t.cip™, in.stik™, heat.wav™, Y Series™, and their respective logos are Trademarks of Gecko Alliance Group.

All other product or company names that may be mentioned in this publication are tradenames, trademarks or registered trademarks of their respective owners.



Introduction



Y Series

whatever the spa,
this is your control system

This product is the simplest, most flexible solution when it comes to supporting even the most complex array of spa add-ons and options.

The Y Series offers the kind of simplicity that makes for a genuine top-of-its-class product. It is the natural choice for anyone who wants an easy-to-understand multi-application solution.

With the Gecko Y Series you don't have to wonder about compatibility; instead, there's just the comforting certainty that when you invest in the Y Series, all spa configurations are supported.

What's more, it also takes into account future compatibility, so you can enjoy peace of mind knowing that you can enjoy the Y Series for years to come.



Features

The Y Series systems boast a long list of technical features. Each of them contributes to bringing the most advanced solutions available to Y Series equipped spa owners:



In.put
input terminal block

In.put was designed to ease wire insertion (up to # 4 AWG) and connections. Tighter input connection reduces heat generated for increased component lifetime.



In.flo
dry-fire protect

A heater safety system located on the heat.wave heater with an all-electronic dry-fire protection.



In.seal
watertight protection

In.seal provides an extra level of protection against water infiltration. Connectors and power box are designed to be watertight so that no water can be in direct contact with electrical components (IPX5).



In.t.cip
water temperature algorithm

In.t.cip is an intelligent water temperature refresh algorithm that calculates optimal time to start pumps and get water temperature readings. In.t.cip continuously readjusts the heater start time.



In.stik
automated software upload

In.stik is a pen drive with an in.link connector very similar to a USB memory stick. It connects to the spa pack and contains data to program or configure its system. The system executes the data upload automatically.



In.link
ingenious plugs and connectors

The Y Series is only compatible with the low-voltage family of in.link connectors, such as those used by keypads and similar low-voltage accessories.



In.touch
you're always in touch with your relaxation

All Yseries packs support the in.touch WiFi interface, allowing you to use your favorite iOS device to communicate with your spa.

Specifications

Refer to the detailed specification chart printed on page 54.



in.ye overview:

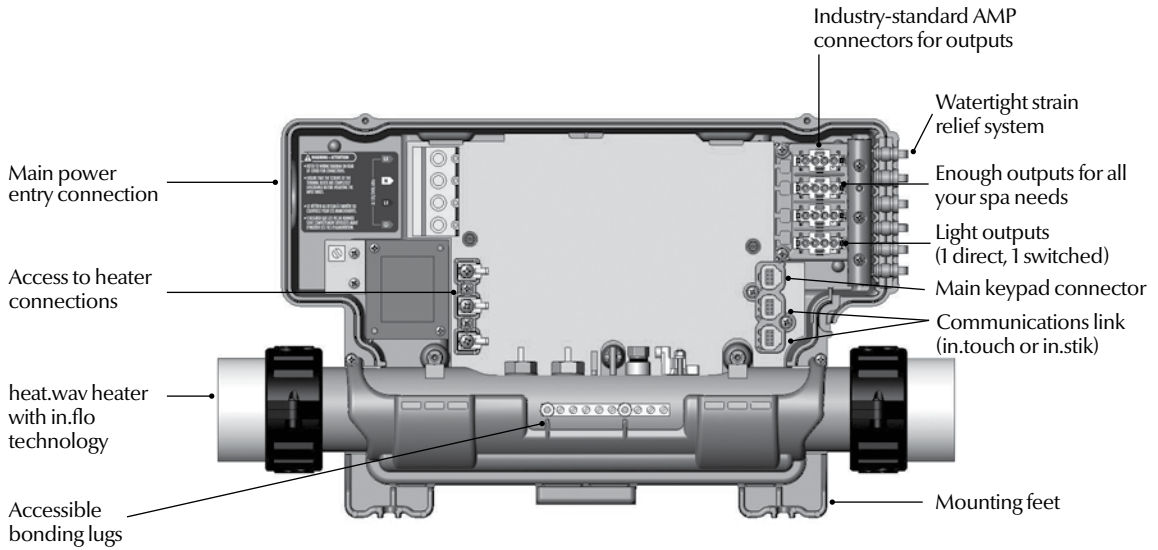

in.ye dimensions:

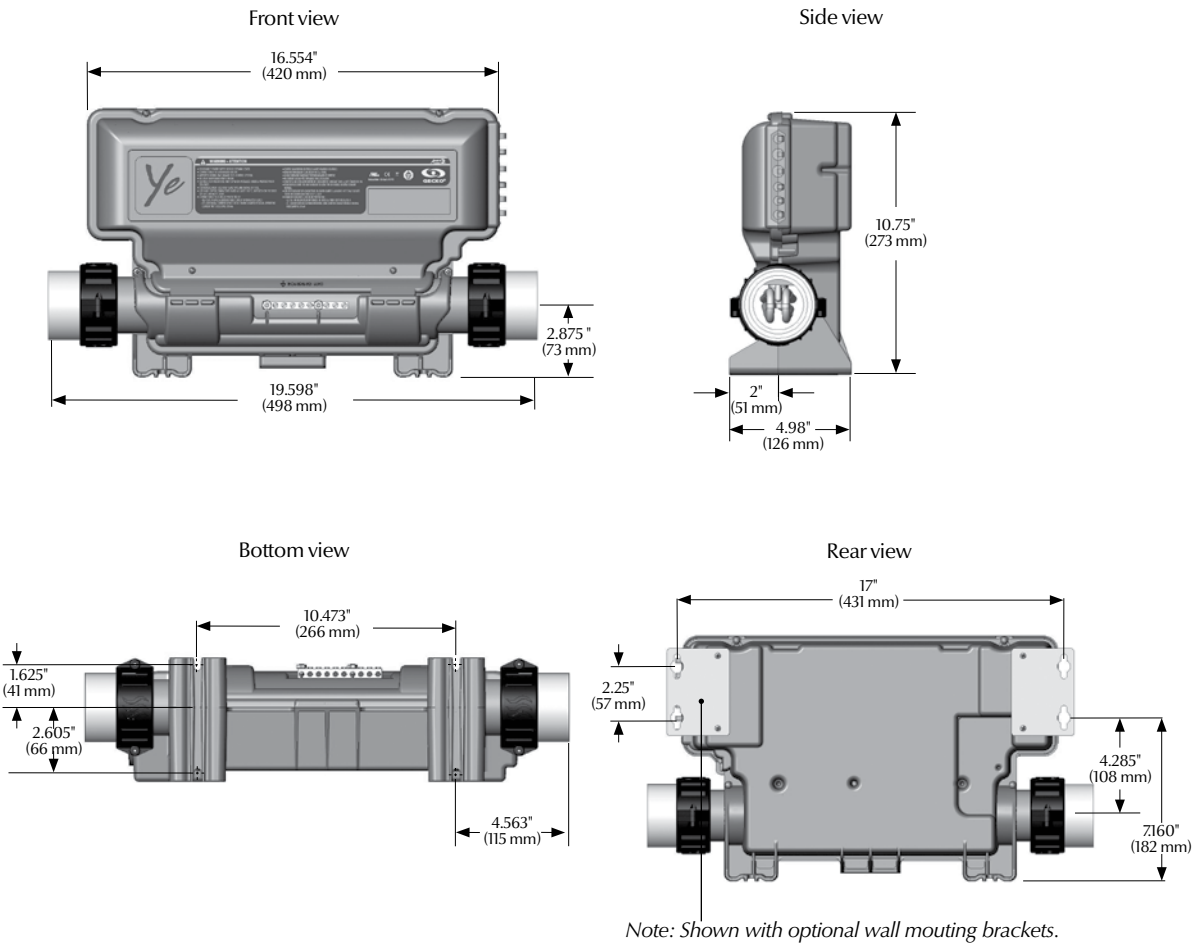



in.yt overview:

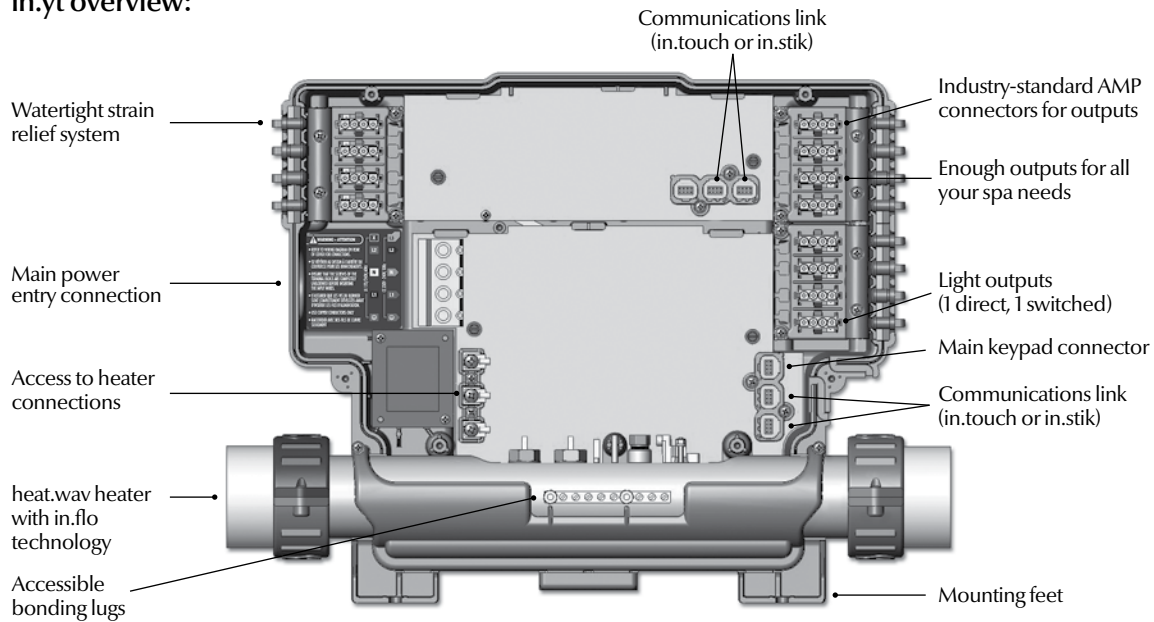

in.yt dimensions:

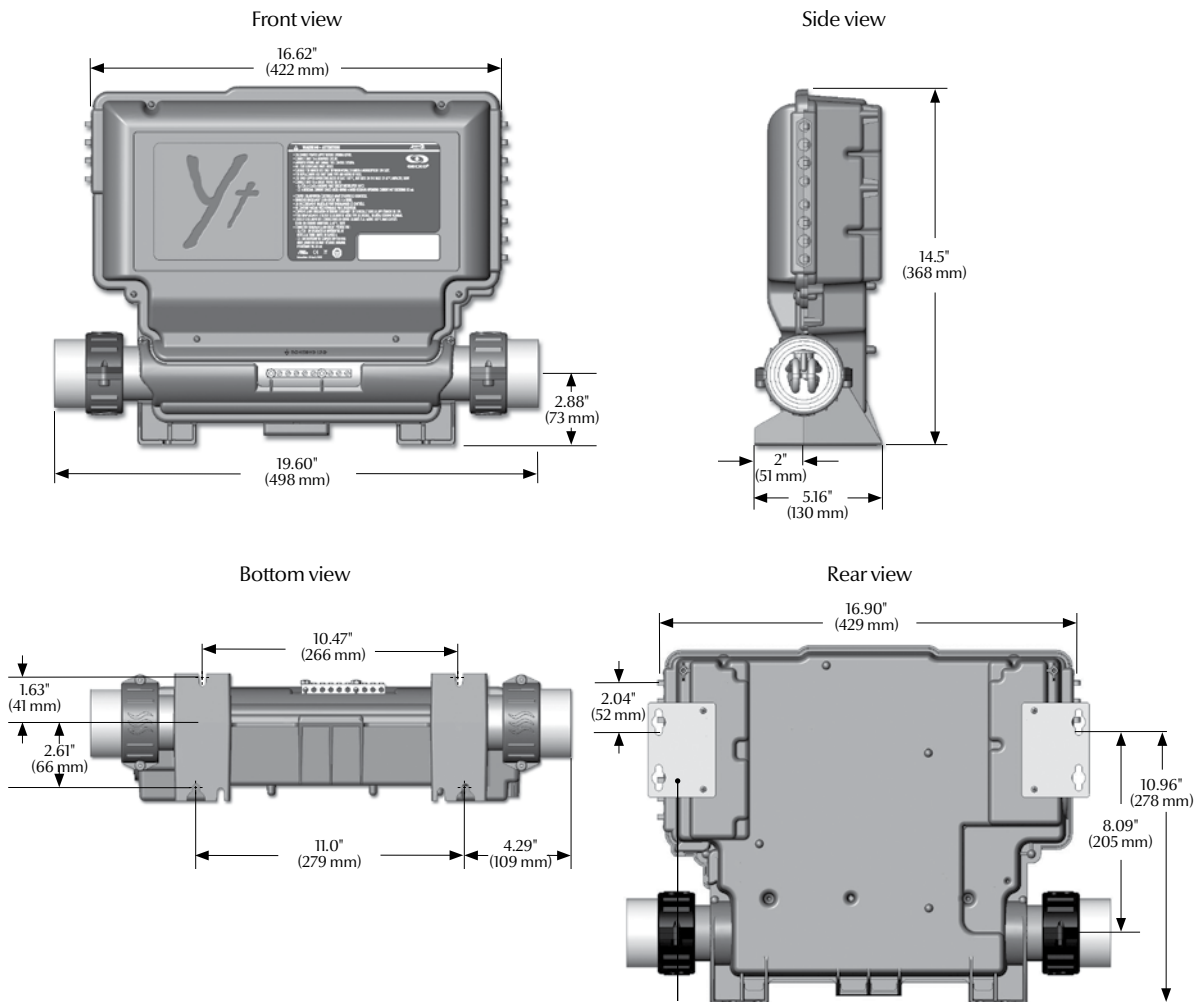

Note: Shown with optional wall mounting brackets.



in.k200 dimensions:

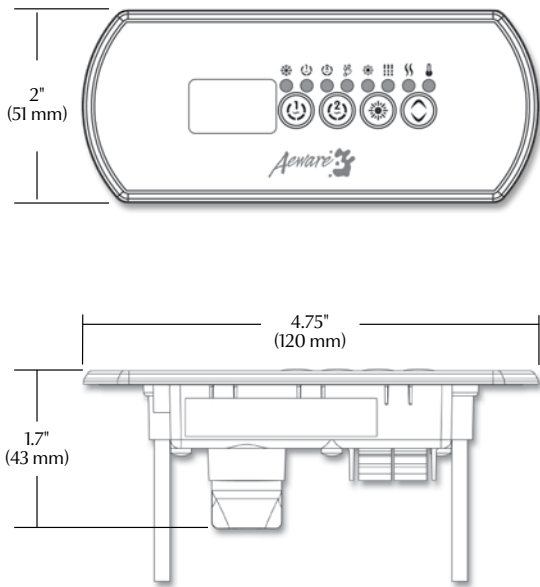

Features:

- LED display
- 4 keys
- 8 light indicator
- in.link connector

Mechanical Specs:

- Weight: 0.9 lbs (0.41 kg)
- Dimensions (W x H x D): Front panel: 4.75" x 2" x 1.7" (120 mm x 51 mm x 43 mm)
- Soft gasket

Approvals:

- UV resistance (ASMTD4329)
- UL, CSA, TUV and CE

Y Series installation

Floor installation procedure with optional guide plate

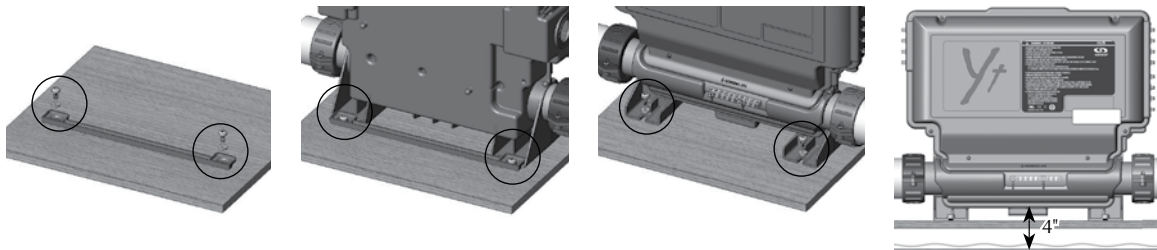

The following material is recommended:

- 4- # 10 screws of appropriate length with round, truss or pan head.
- 4- washers 1/2" OD x 1/16" thickness (12 mm OD x 1.5 mm)

Select the most appropriate location on the floor for spa pack and firmly attach guide plate to wooden base with 2 screws backed by 2 washers.

Slide back side of the unit's feet into the guide plate. It should easily slide into place.

Now firmly attach unit to wooden base by using the remaining 2 screws backed by 2 washers to attach the front feet.

Note: The spa pack must be installed at least 4" (52 mm) above potential flood level. If floor is on ground level, pack should be raised at least 4" (52 mm).

Warning!

Beware the application of some products commonly used against corrosion (such as WD-40 family products) as they could damage the power box, due to a negative chemical reaction between some industrial oils and its plastic enclosure. Any other materials which may come in contact with the enclosure must be carefully evaluated under end use conditions for compatibility.

Important!

Please note that countersunk screws should not be used as they can damage the power box support.



Floor installation procedure without guide plate

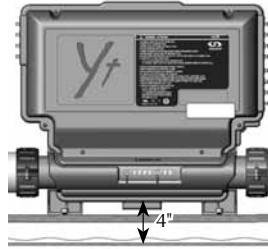
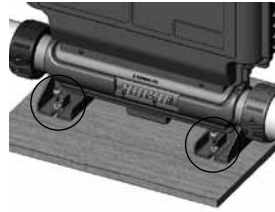
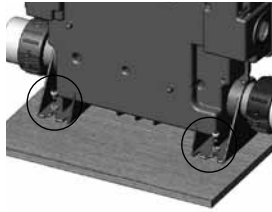

The following material is recommended:

4- # 10 screws of appropriate length with round, truss or pan head.

4- washers 1/2" OD x 1/16" thickness (12 mm OD x 1.5 mm)

Now firmly attach the front feet of the pack to the wooden floor using 2 more screws backed by 2 washers.

Note: The spa pack must be installed at least 4" (52 mm) above potential flood level. If floor is on ground level, pack should be raised at least 4" (52 mm).

Important!

Please note that countersunk screws should not be used as they can damage the power box support.

Select the most appropriate location on the floor for the spa pack and firmly attach the 2 rear feet to the wooden base using 2 screws backed by 2 washers.

Warning!

Beware the application of some products commonly used against corrosion (such as WD-40 family products) as they could damage the power box, due to a negative chemical reaction between some industrial oils and its plastic enclosure. Any other materials which may come in contact with the enclosure must be carefully evaluated under end use conditions for compatibility.

Wall installation procedure with optional wall mounting brackets

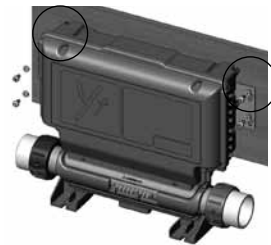
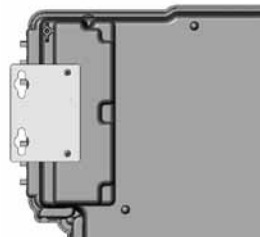
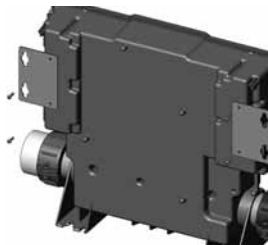

Install mounting brackets on both sides of rear of unit, using the screws provided with the bracket.

The following material is recommended:

4- # 10 screws of appropriate length with round, truss or pan head.

4- washers 1/2" OD x 1/16" thickness (12 mm OD x 1.5 mm)

Firmly attach, one at a time, upper mounting holes on each side of the spa pack with 2 screws backed by 2 washers.

Firmly attach lower mounting holes on each side of the pack with the 2 remaining screws and 2 washers. Lower mounting holes are 2" (51mm) below upper holes.

Use 2 standard 2x4 or 2x6 wall studs, spaced on 17-inch centers to affix the spa pack.



in.k200 installation & connections

Installing the in.k200

The keypad should be installed directly onto the spa (or very close to it) so that it is easily accessible to the user.

- To install the in.k200, drill two 1" (25 mm) diameter holes at 2 5/8" (67 mm) from center to center as illustrated.
- Cut out the material between the two holes (see illustration).
- Clean the installation surface and peel the adhesive backing from the keypad.
- Insert keypad and align it correctly, then ensure it is properly glued by gently pressing evenly on the entire surface.

If the keypad is equipped with an optional holder plate, remove the two wing nuts from the back of the keypad and remove the mounting bracket.

Insert the keypad into the opening you have cut out. Put the mounting bracket and the wing nuts back on their respective bolts and fix the keypad securely in place (see illustration below).

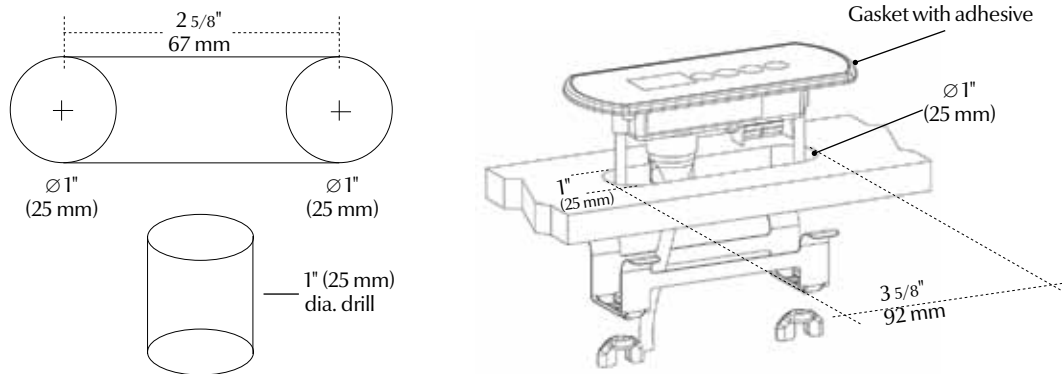

Note: It is the installer's responsibility to ensure that no obstructions (cables, piping, etc.) are present below the deck at the drill hole location.

Note: If the installation location is not perfectly even (e.g. wood surface), make a silicone joint between the installation surface and the back of the unit to ensure a proper seal around it.

Connecting the main keypad to the spa pack

The in.k200 comes with a 10' (3.048 m) cable and an in.link connector.

To connect the in.k200, first remove the cover (for in.ye 4 screws and for in.yt 6 screws), then insert the in.link connector into the appropriate keypad connector (as illustrated). Route the cable through one of the molded strain relief channels on the bottom right side of the spa pack (as illustrated). Don't forget to replace the cover and all screws (do not over tighten cover screws).

Note: always shut power down before connecting an accessory to the in.ye or in.yt.

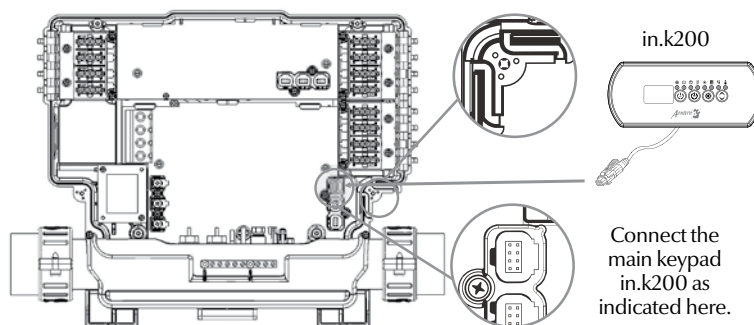



Y Series connections

Electrical wiring for North American model of the Y Series

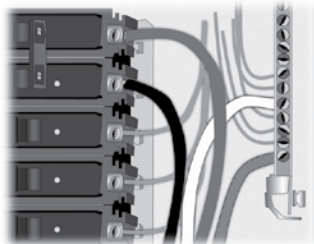
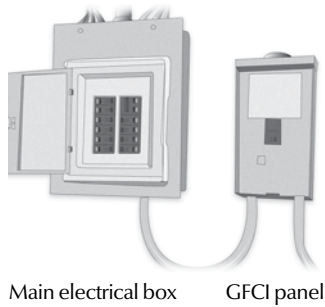

Warning!

For units for use in other than single-family dwellings, a clearly labeled emergency switch shall be provided as part of the installation. The switch shall be readily accessible to the occupants and shall be installed at least 5' (1.52 m) away, adjacent to, and within sight of the unit.

This product must always be connected to a circuit protected by a ground fault interrupter.

Proper wiring of the electrical service box, GFCI and in.yt terminal block is essential!

Check your electrical code for local regulations. Only copper wire should be used, never aluminum.



Disposal of the product

The appliance (or the product) must be disposed of separately in accordance with the local waste disposal legislation in force.

Electrical wiring for North American or CE model of the Y Series

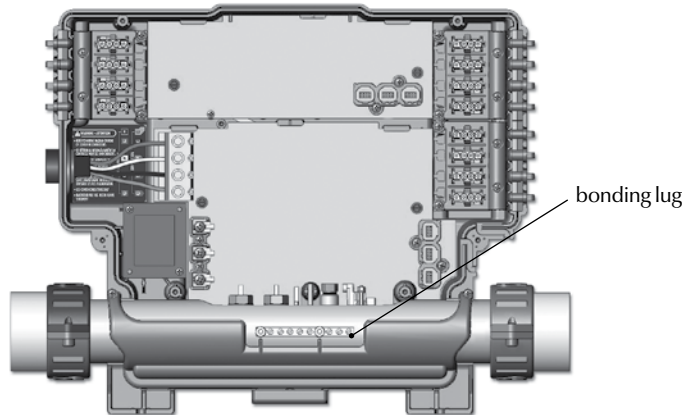

To install the wiring for the Y Series spa control, you'll need a Phillips screwdriver and a flat screwdriver.

Loosen the 4 or 6 screws of the spa pack cover and remove it. Remove 5 1/2" (142 mm) of cable insulation. Strip away 1" (25 mm) of each wire insulation. Pull the cable through the cutout of the box and secure it with a strain relief (1" NPT strain relief; hole diameter: 1.335").

(For CE use an IEC certified plastic bushing that will maintain the IPX5 rating.)

Make sure that only the uncut sheathing is clamped at this opening. Make sure that the terminal block case clamps are lowered before inserting wires.

Push the color-coded wires into the terminals as indicated on the sticker and use the flat screwdriver to tighten the screws on the terminals.

After making sure wire connections are secure, push them back into the box and replace the cover. Tighten the 4 or 6 screws of the spa pack cover. Do not over tighten cover screws.

Connect the bonding conductor to the bonding lug on the front of the Y Series spa pack (a grounded electrode conductor shall be used to connect the equipment grounding conductors).



Y Series electrical wiring North American model

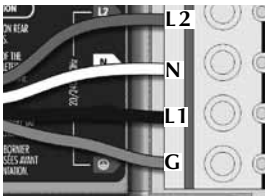

For 240 V (4 wires)

Correct wiring of the electrical service box, GFCI, and pack terminal block is essential.

Call an electrician if necessary.

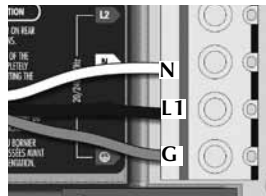

For 120 V (*3 wires)

*If connected to a 3 wire system, no 240 V component will work.

Refer to "Connections for 120 V heater" section of this manual.

Refer to heater connection section for proper connections of ORANGE and BROWN wires.

in.ye electrical wiring European model

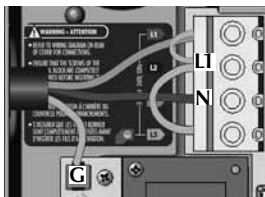

1-phase

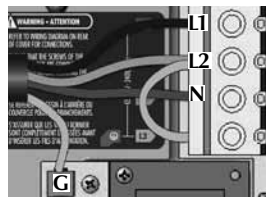

2-phases with single neutral

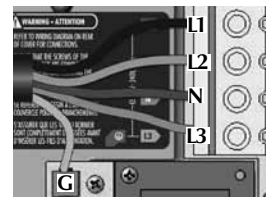

3-phases with single neutral

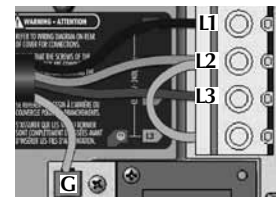

3-phases Delta

In.ye.ce 230 V AC or 230/400 V AC

Correct wiring of the electrical service box, RCD, and pack terminal block is essential!
Call an electrician if necessary.

Refer to heater connection section for proper connections of ORANGE and BROWN wires.

Warning!

In.ye.ce models must always be connected to a circuit protected by a Residual-Current Device (RCD) having a rated operating residual-current not exceeding 30 mA.

in.yt electrical wiring European model

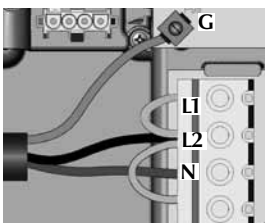

1-phase

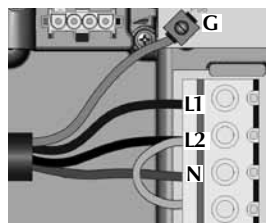

2-phases with single neutral

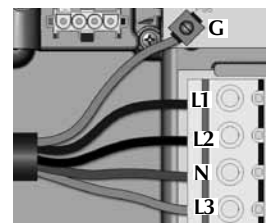

3-phases with single neutral

In.yt.ce 230 V AC or 230/400 V AC

Correct wiring of the electrical service box, RCD, and pack terminal block is essential!
Call an electrician if necessary.

Refer to heater connection section for proper connections of ORANGE and BROWN wires.

Warning!

In.yt.ce models must always be connected to a circuit protected by a Residual-Current Device (RCD) having a rated operating residual-current not exceeding 30 mA.



Heater connections

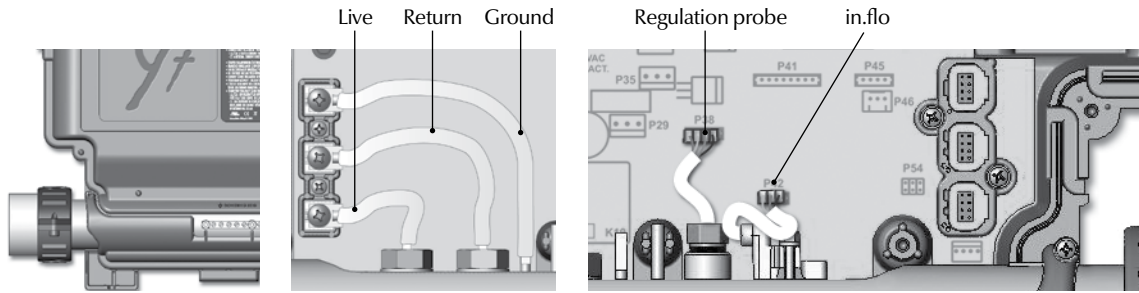

Heat.wav heater

The Y Series systems come with a high performance heat.wav heater. With no pressure switch, it features in.flo integrated dry-fire protection.

The watertight cover protects the heater and probe connectors. Removing the cover gives access to in.flo dry-fire protection and hi-limit/regulation probe connectors, live, return, and ground cable connections.

The heat.wav heater is factory configured for 240 V / 4 kW, but it can be converted to a dedicated 120 V / 1 kW by simply switching a cable connection. (120 V conversion is available on North American in.ye-3 models only).

Heat.wav specification summary:

- Supports 120 V or 240 V
- Protected by external breaker (not fused)*
- Incoloy® or Titanium (optional) heater element for greater protection against corrosion.
- Optional 5.5 kW, 240 V heater is available.

**Note: European models are 230-240 V only, and are fuse protected*

All heater connections are accessible when the cover is removed. Connections include the in.flo dry-fire protection, hi-limit/regulation probe connectors, power and ground cable connections.

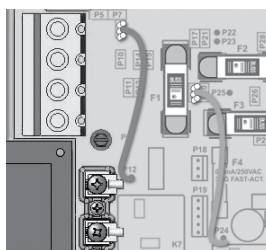

Connections for all 240 V heaters (North American installations only)

BROWN wire must be correctly and completely connected between P12 and P9.

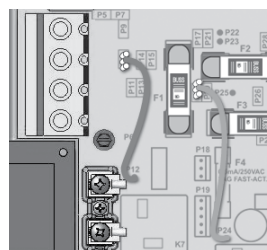

Connections for all 120 V heaters (North American installation in.ye-3 only)

BROWN wire must be correctly and completely connected between P12 and P10.

Connections for all 230 V AC heaters (CE installations only)

The heater is permanently connected to line 2 via FI. You have no jumper to manage.

Note: To convert a 240 V North American model to 120 V simply move the BROWN connection from P9 to P10.



Power-up & breaker setting

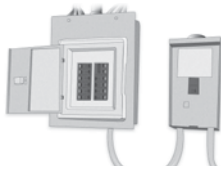

IMPORTANT!
 Turn off the breaker.
 Make sure all accessories are linked to the bonding connector and connected to pack.
 Turn on the breaker.

Boot up display sequence (Each parameter is displayed for 2 seconds)



Lamp test

All the segments and LEDs light up.



Software number

Software part number



Software revision

Revision of the software

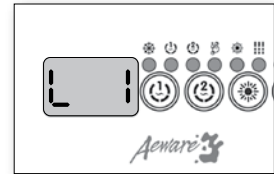

Low-level selection

Low-level selected from low-level menu

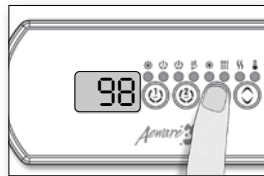

It's important to specify the current rating of the GFCI used to ensure safe and efficient current management (and reduce nuisance GFCI trippings).

Press and hold **Prog** button until you access the breaker setting menu.

Note: if the keypad in use does not have the **Prog** key, use the **Light** key instead.



The values displayed by the system correspond to 0.8 of the maximum amperage capacity of the GFCI.

Use **Up** or **Down** button to select the desired value.

The value can be modified typically from 10 to 48 AMP for UL version, and 10 to 40 AMP for CE version.



Then press **Prog** button to set breaker rating. This table shows typical settings of b for different GFCI ratings. Select the one that matches your breaker.

GFCI	b
60 Amp	48 Amp
50 Amp	40 Amp
40 Amp	32 Amp
30 Amp	24 Amp
20 Amp	16 Amp

Note: Every OEM has its own preset configurations.

Valuable Tip

Make sure that all valves are open in the spa plumbing and that you have good water flow circulation from the primary pump into the heater.

Important: a minimum flow rate of 18 GPM is required.

Technical stuff

There is no mechanical blow or pressure switch in the Y Series heater. Instead Y Series systems have integrated in.flo technology. The in.flo is an all-electronic dry-fire protection device built into the heater. At power up, the in.flo detector performs a flow check through the following process:

Pump 1 or circulation pump starts for 2 minutes. The display will show " __ " during the check flow process. After 2 minutes the system validates proper water flow.

In case of failure, the systems tries again. The water temperature is shown on the keypad display. Once the water has reached the set point value plus 0.8°F the heater is turned off.

Programming the Y Series

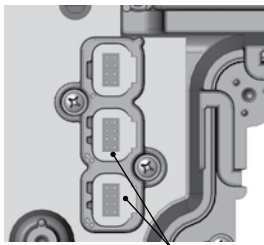

communications port

Programming the Y Series using the in.stik

This feature is very useful on production lines to configure packs and in the field for service purposes like software updates.

Follow these simple steps to upload new pre-determined low-level program configurations into the spa pack.

Shut electrical power off.

Remove the cover to access the low-voltage in.link connectors inside, connect the in.stik to the communications port (see figure), and then re-apply power to pack.

At power-up the spa pack will upload all the different configurations from the in.stik memory.

The unit will then enter the low-level configuration menu.

The keypad display will show Lxx where "xx" represents the previous configuration number registered in the system.

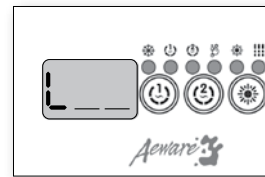
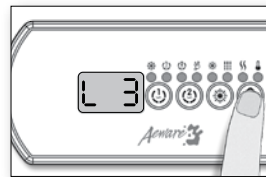

Use the **Up/Down** key to choose the new desired low-level configuration number.

Press the **Prog** key to confirm the selected configuration (see configuration selection charts).

If the **Prog** key is not pressed within 25 seconds, the unit will exit this menu without changing any settings.

*Note: If the keypad in use does not have the **Prog** key, use **Light** key instead.*

If, when the system powers up, your keypad display shows the following message:

"L _ _", it means that all low-level configurations have been downloaded, but no configuration number has been chosen.

Note: When programming is finished, do not forget to turn power off, remove the in.stik, and re-install the pack's cover.

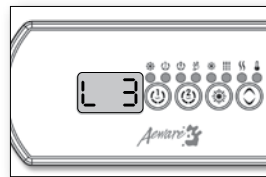
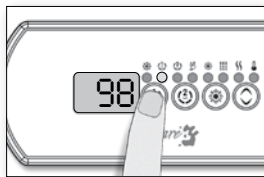

Programming the Y Series using the keypad

Although every Y Series spa pack is factory set, in certain cases when servicing or replacing a new unit in the field, it may be necessary to set a new pre-determined low-level program configuration into the spa pack.

Follow these simple steps to re-enter the low-level programming menu using the keypad:

Press and hold the **Pump 1** key for 30 seconds.

The keypad display will show Lxx where "xx" represents the previous configuration number registered in the system.

Use the **Up/Down** key to choose the new desired low-level configuration number and press the **Program** key to confirm the selected configuration (refer to the configuration selection chart section in this manual).

If the **Program** key is not pressed within 25 seconds, the unit will exit this menu without changing any settings.

If at power-up of the system your keypad display shows the following message: "L _ _", it means that all low-level configurations have been downloaded, but no configuration number has been chosen.

*Note: If the keypad in use does not have the **Program** key, use the **Light** key instead.*



Low-level configuration selection charts

1- In.ye-3 with low-level 177 revision 1.

Config. #	A1	A2	A3	CP configuration	Ozone configuration	Filter Type	Heater Pump
out H	out 4	out 5	out 2				
out L	---	---	out 5				
1	O3	---	P1, 2sp	---	On during Filter cycle, with P1	Clean, P1L	P1
2	O3/CP	---	P1, 2sp	Always on	---	Purge	CP
3	O3/CP	P2, 1sp	P1, 1sp	Always on	---	Purge	CP
4	O3/CP	P2, 1sp	P1, 1sp	During filtration	---	Clean, CP	CP

2- In.ye-5 with low-level 178 revision 2.

Config. #	A1	A2	A3	A4	FL	CP configuration	Ozone configuration	Filter Type	Heater Pump
out H	out 4	out 1	out 2	out 3	out 13				
out L	---	out 3	out 5	---	---				
1	O3	---	P1, 2sp	---	DIR	---	On during Filter cycle, with P1	Clean, P1L	P1
2	O3/CP	---	P1, 2sp	---	DIR	Always on	---	Purge	CP
3	O3	P2, 2sp	P1, 2sp	---	DIR	---	On during Filter cycle, with P1	Clean, P1L	P1
4	O3/CP	P2, 2sp	P1, 2sp	---	DIR	Always on	---	Purge	CP
5	O3/CP	P2, 1sp	P1, 2sp	P3, 1sp	DIR	During filtration	---	Clean, CP	CP

Note 1: Every OEM has its own preset configurations. The low-level configuration may differ depending on the manufacturer.
 Note 2: If both CP and ozone accessories are used (controlled by same output), configure output O3 as unused.

in.ye-3

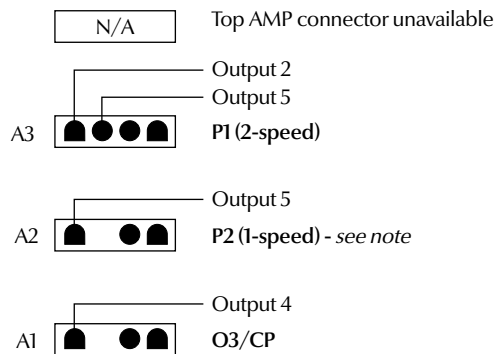
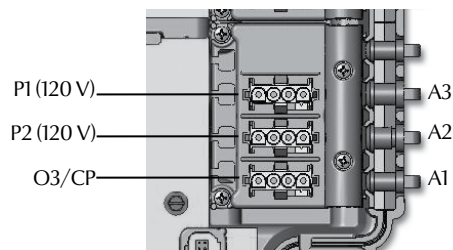

Note: If P2 is used, P1L cannot be used.

in.ye-5

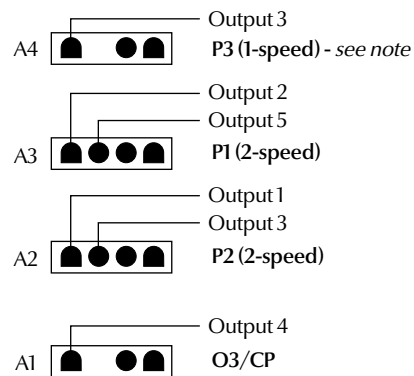
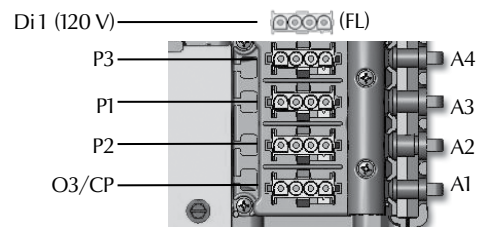

Note: If P3 is used, P2L cannot be used.



3- In.yt-7 with low-level 179 revision 1.

Config. #	A1	A2	A3	A4	C1	C2	C3	CP configuration	Ozone configuration	Filter Type	Heater Pump
out H	out 4	out 1	out 2	out 13	out 14	out 6	out 8				
out L	---	out 3	out 5	---	---	---	out 6				
1	O3	P2, 2sp	P1, 2sp	DIR	DIR	CP	P3, 1 SP	During filtration	On during Filter cycle, with CP	Clean, CP	CP
2	O3	P2, 2sp	P1, 2sp	DIR	DIR	---	P3, 2 SP	---	On during Filter cycle, with P1	Clean, P1L	P1

in.yt-7

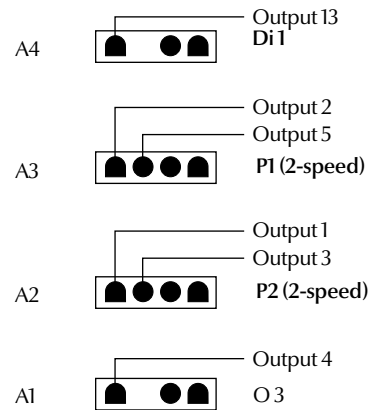
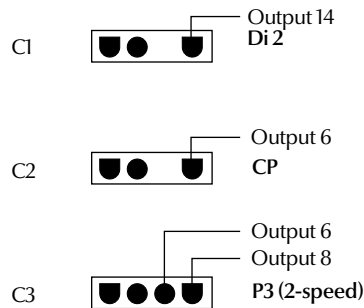
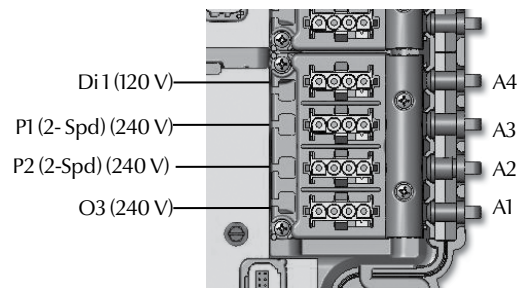
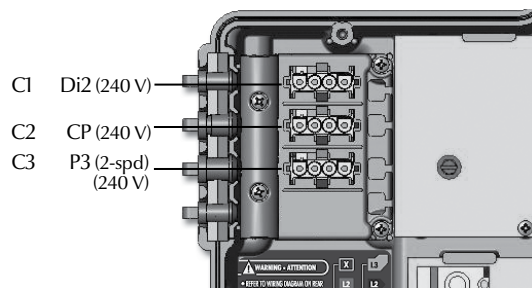

Note: If P3, 2 speed is used, CP must be on output 4 with the ozone.



4- In.yt-12 with low-level 180 revision 1.

Config.#	A1	A2	A3	A4	B1	B2	B3	B4	C1	C2	C3	CP configuration	Ozone configuration	Filter Type	Heater Pump
	out H	out 4	out 1	out 2	out 13	out 10	out 9	out 12	out 11	out 14	out 7	out 8			
	out L	---	out 3	out 5	---	---	out 10	---	---	---	---	out 6			
1	O3	P2, 2sp	P1, 2sp	DIR	A1	P4, 1sp	P5, 1sp	BL	DIR	CP	P3, 2sp	During filtration	On during Filter cycle, with CP	Clean, CP	CP
2	O3	P2, 2sp	P1, 2sp	DIR	---	P4, 2sp	P5, 1sp	BL	DIR	O3/CP	P3, 2sp	During filtration	On during Filter cycle, with CP	Clean, CP	CP

in.yt-12

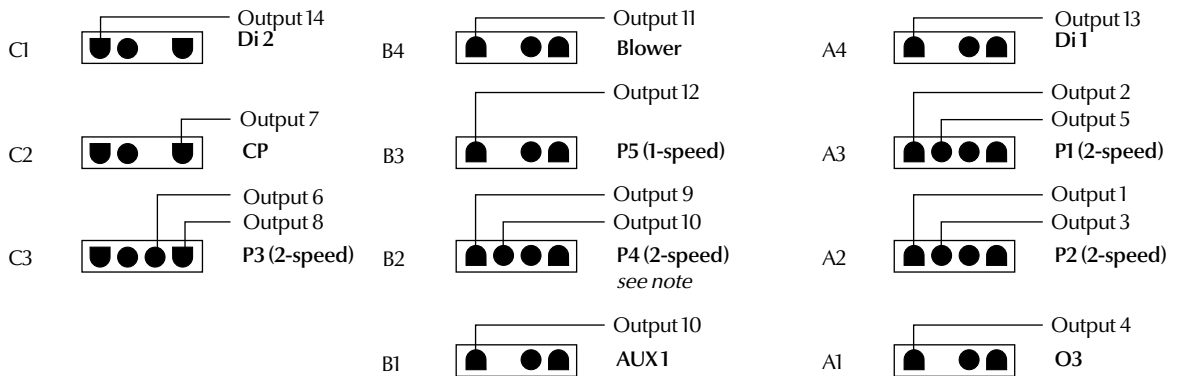
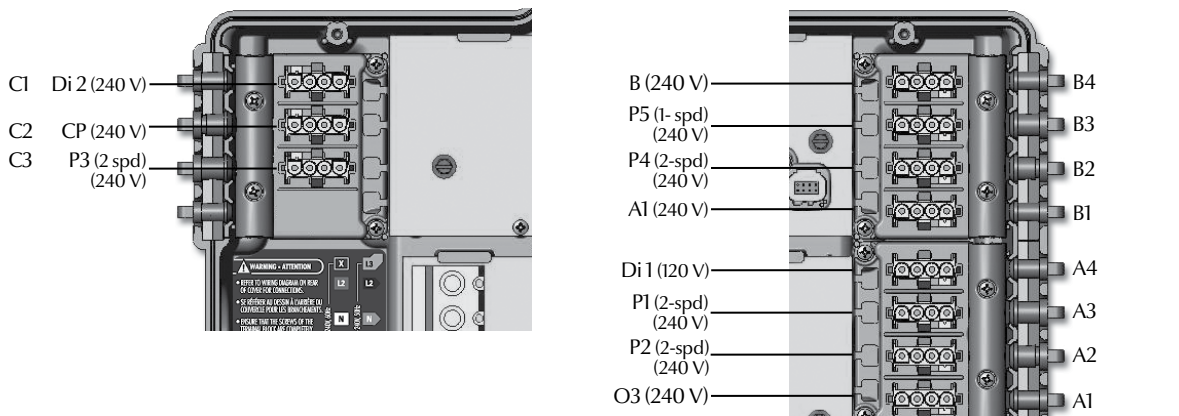

Note: If P4 2 speed is used, AUX 1 can not be used.



Y Series field programming options

In the event that none of the pre-determined low-level program configurations built in the unit's system suit your spa equipment assembly, it's possible to custom configure the system by manually entering key parameter settings.

To access this menu, press and hold **Prog** (or **Light** key) for 30 seconds. Use **Up** or **Down** key to choose setting. Press **Prog** key (or **Light** key) to go to the next parameter.

Table 1

Parameter	Display	Options	Description
Output 1	1. _ _	--,1H,1L,2H,2L,3H,3L,4H,4L,P5,BL,CP,O3,L2,H, ON	Accessory connected to relay Output 1
Output 2	2. _ _	--,1H,1L,2H,2L,3H,3L,4H,4L,P5,BL,CP,O3,L2,H, ON	Accessory connected to relay Output 2
Output 3	3. _ _	--,1H,1L,2H,2L,3H,3L,4H,4L,P5,BL,CP,O3,L2,H, ON	Accessory connected to relay Output 3
Output 4	4. _ _	--,1H,1L,2H,2L,3H,3L,4H,4L,P5,BL,CP,O3,L2,H, ON	Accessory connected to relay Output 4
Output 5	5. _ _	--,1H,1L,2H,2L,3H,3L,4H,4L,P5,BL,CP,O3,L2,H, ON	Accessory connected to relay Output 5
Output 6	6. _ _	--,1H,1L,2H,2L,3H,3L,4H,4L,P5,BL,CP,O3,L2,H, ON	Accessory connected to relay Output 6
Output 7	7. _ _	--,1H,1L,2H,2L,3H,3L,4H,4L,P5,BL,CP,O3,L2,H, ON	Accessory connected to relay Output 7
Output 8	8. _ _	--,1H,1L,2H,2L,3H,3L,4H,4L,P5,BL,CP,O3,L2,H, ON	Accessory connected to relay Output 8
Output 9	9. _ _	--,1H,1L,2H,2L,3H,3L,4H,4L,P5,BL,CP,O3,L2,H, ON	Accessory connected to relay Output 9
Output 10	A. _ _	--,1H,1L,2H,2L,3H,3L,4H,4L,P5,BL,CP,O3,L2,H, ON	Accessory connected to relay Output 10
Output 11	b. _ _	--,1H,1L,2H,2L,3H,3L,4H,4L,P5,BL,CP,O3,L2,H, ON	Accessory connected to relay Output 11
Output 12	C. _ _	--,1H,1L,2H,2L,3H,3L,4H,4L,P5,BL,CP,O3,L2,H, ON	Accessory connected to relay Output 12
Output 13	d. _ _	--,CP	Accessory connected to the Direct Output 1
Output 14	E. _ _	--,CP	Accessory connected to the Direct Output 2
Heater	H. _ _	--,H	Accessory connected to the heater relay
CP usage	Cu. _ _	CP Standard = 0 CP Always On = 1	Usage of the circulation pump
Ozone usage	ou. _ _	Ozone with filtration = 0 Ozone Always On = 1	Usage of the ozone generator
Ozone Pump	oP. _ _	Circulation pump = 0 Pump #1 = 1	Pump associated with the ozone generator
Ozone Type	o. _ _	Standard (UV) = 0 Timed (Corona) = 1	Type of ozone generator
Heater Pump	HP. _ _	Circulation pump = 0 Pump #1 = 1	Pump associated with the Heater
Filter Config	FL. _ _	Purge only = 0 With Circ. Pump = 1 With Pump 1, Low speed = 2	Filter cycle configuration
Temp. Units	Un. _ _	°F = 0 °C = 1	Temperature units used on display
Clock Format	CL. _ _	No time display = 0 AM/PM format = 1 24H format = 2	Clock display format



Table 1

Parameter	Display	Options	Description																							
Cool down	C_ _ _	30 to 240 seconds	Cool down of the heating element in seconds																							
Output 1 current	1_ _ _	0 to 15 amperes	Current draw of Output 1 accessory																							
Output 2 current	2_ _ _	0 to 15 amperes	Current draw of Output 2 accessory																							
Output 3 current	3_ _ _	0 to 15 amperes	Current draw of Output 3 accessory																							
Output 4 current	4_ _ _	0 to 15 amperes	Current draw of Output 4 accessory																							
Output 5 current	5_ _ _	0 to 15 amperes	Current draw of Output 5 accessory																							
Output 6 current	6_ _ _	0 to 15 amperes	Current draw of Output 6 accessory																							
Output 7 current	7_ _ _	0 to 15 amperes	Current draw of Output 7 accessory																							
Output 8 current	8_ _ _	0 to 15 amperes	Current draw of Output 8 accessory																							
Output 9 current	9_ _ _	0 to 15 amperes	Current draw of Output 9 accessory																							
Output A current	A_ _ _	0 to 15 amperes	Current draw of Output 10 accessory																							
Output B current	b_ _ _	1 to 15 amperes	Current draw of Output 11 accessory																							
Output C current	C_ _ _	1 to 15 amperes	Current draw of Output 12 accessory																							
Output D current	d_ _ _	1 to 5 amperes	Current draw of Direct output 1 accessory																							
Output E current	E_ _ _	0 to 5 amperes	Current draw of Direct output 2 accessory																							
Output H current	H_ _ _	0 to 17 amperes	Current draw of the heater																							
CE Configuration	CE_ _	UL = 0 CE = 1	CE or UL setup																							
Number of phases	P_ _ _	1 or 2 (UL) 1, 2 or 3 (CE)	Number of Phases / Breakers <table border="1"> <thead> <tr> <th colspan="2">Number of Phases selection</th> </tr> </thead> <tbody> <tr> <td>UL</td> <td>Menu not available</td> </tr> <tr> <td>CE</td> <td>1, 2 or 3</td> </tr> <tr> <td>UL Swim</td> <td>1 or 2</td> </tr> <tr> <td>CE Swim</td> <td>1, 2 or 3</td> </tr> </tbody> </table>	Number of Phases selection		UL	Menu not available	CE	1, 2 or 3	UL Swim	1 or 2	CE Swim	1, 2 or 3													
Number of Phases selection																										
UL	Menu not available																									
CE	1, 2 or 3																									
UL Swim	1 or 2																									
CE Swim	1, 2 or 3																									
Input current	b_ _ _	10 to 60A Single Phase (UL and CE) 10 to 48A Dual Phase (UL) 10 to 40A Dual Phase (CE) 10 to 20A Triple Phase (CE)	Available household current <table border="1"> <thead> <tr> <th rowspan="2"></th> <th colspan="3">Maximum Input Current</th> </tr> <tr> <th>1 phase</th> <th>2 Phases</th> <th>3 Phases</th> </tr> </thead> <tbody> <tr> <td>UL</td> <td>48</td> <td>na</td> <td>na</td> </tr> <tr> <td>CE</td> <td>48</td> <td>20</td> <td>16</td> </tr> <tr> <td>UL Swim</td> <td>60</td> <td>48</td> <td>na</td> </tr> <tr> <td>CE Swim</td> <td>60</td> <td>40</td> <td>20</td> </tr> </tbody> </table>		Maximum Input Current			1 phase	2 Phases	3 Phases	UL	48	na	na	CE	48	20	16	UL Swim	60	48	na	CE Swim	60	40	20
	Maximum Input Current																									
	1 phase	2 Phases	3 Phases																							
UL	48	na	na																							
CE	48	20	16																							
UL Swim	60	48	na																							
CE Swim	60	40	20																							



AMP pins and housings

Industry standard AMP pins and housings are supported as well. Also, a special PP-1 splitter can be ordered and used to split an output into 2 parallel outputs (i.e. a single O3 output could be used for an ozonator and UV generator, O3 or CP.)

Depending on the specific model ordered, different numbers of AMP housings are supported. Note that in some instances, a specific output is in reality the low-speed output of the last unused 2-spd accessory. For example, in an in.yt-7, if Pump #3 is a single-speed pump, the unused low speed output can be used as a circulation pump. Both accessories thus driven must be of the same voltage (120 V or 240 V.)

A floating connector is a connector that's not attached to a side bracket. Note that all optional PP-1 splitters are floating (the male end is attached though.)

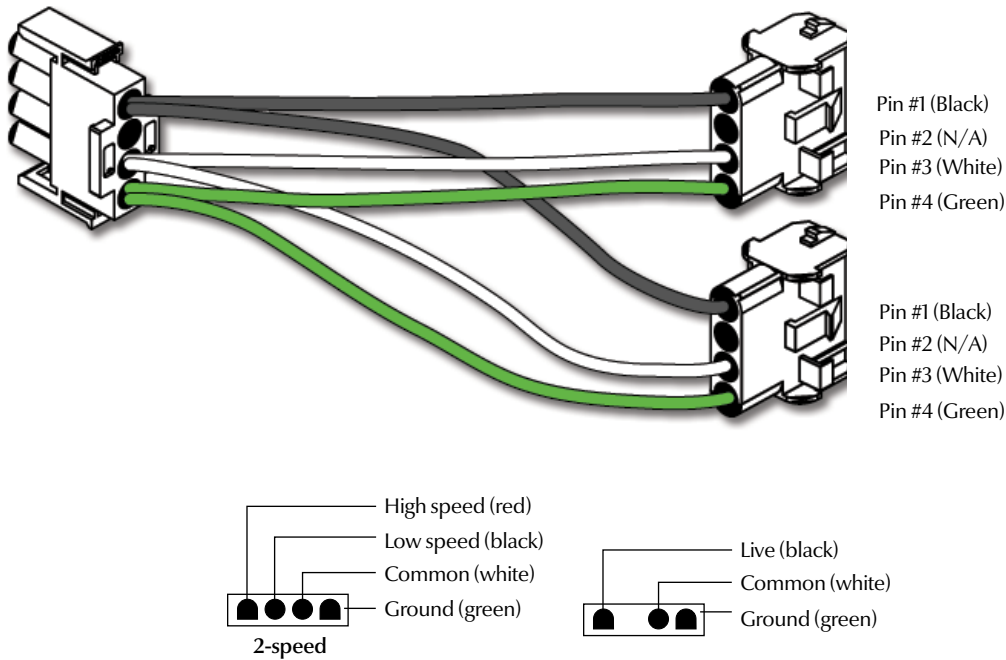



High voltage accessory connections

Two options are available with Y Series spa packs for connecting high voltage accessories: 0.250" quick-connect terminals, or industry standard AMP pins and housings.

In.ye-ce 230 V

These tabs require high-voltage accessories to have straight, non-insulated, female quick-connect terminals for all connections, including ground. Depending on where the connections are made on the in.ye PCB and 230 V accessories are supported. Refer to the following tables for correct connections. Note that all female terminals must be correctly and completely seated on the PCB tab for proper current ratings.

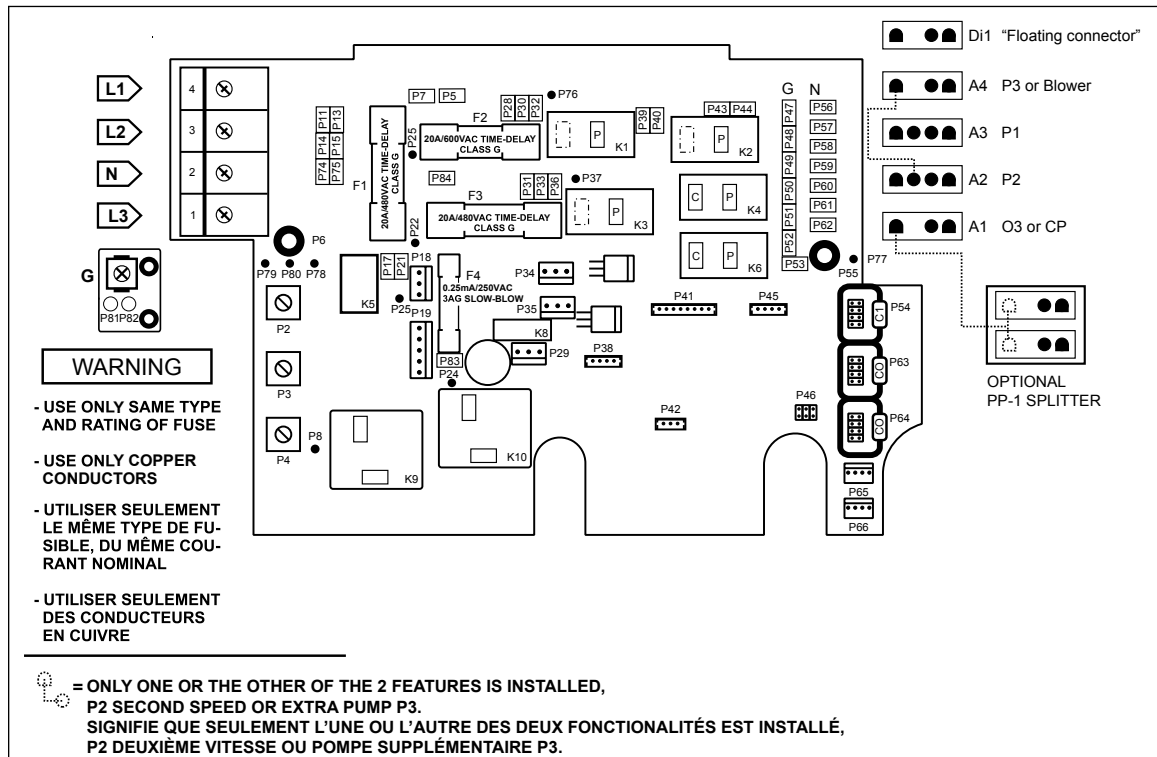

Direct output 1 (in.ye-5 ce only) (Floating connector)		Pump 1 (A3)		Pump 3 (A4) (in.yt-5 ce only)		Ozonator* (A1)	
Voltage		Voltage		Voltage		Voltage	
Green / ground	P47	Green / ground	P49	Green / ground	P48	Green / ground	P52
Black / line	P32	Black / low speed	K2-P	Black / low speed	K6-P	Black / line	K4-P
White / common	P56	Red / high-speed	K1-P	White / common	P57	White / common	P62
		White / common	P59				

Pump 2 (A2)		Circ. pump* (A1)		Blower (A4) (in.ye-5 ce only)		Light (12 V AC, 1A Max.)	
Voltage		Voltage		Voltage		Voltage	
Green / ground	P51	Green / ground	P52	Green / ground	P48	Always on	P34
Black / low speed	K6-P	Black / line	K4-P	Black / line	K6-P	Relay	P35
Red / high-speed	K3-P	White / common	P62	White / common	P57		
White / common	P60						

* Ozonator and circ pump can be combined on the same output via the optional splitter PP1.

This table shows typical connections. OEMs may have a different connection scheme.



in.yt-ce 230 V

These tabs require high-voltage accessories to have straight, non-insulated, female quick-connect terminals for all connections, including ground. Depending on where the connections are made on the in.yt PCB and 230 V accessories are supported. Refer to the following tables for correct connections. Note that all female terminals must be correctly and completely seated on the PCB tab for proper current ratings.

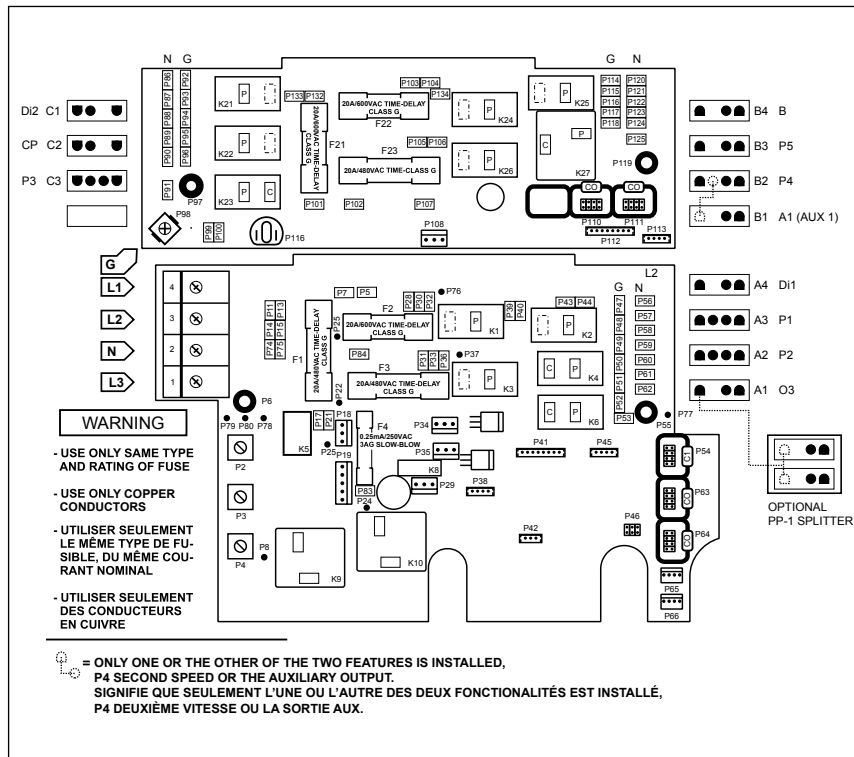

Direct output 1 (A4)	
Voltage	230 V
Green / ground	P47
Black / line	P32
White / common	P56

Direct output 2 (C1) (in.yt only)	
Voltage	230 V
Green / ground	P92
Black / line	P133
White / common	P86

Auxiliary (B1) (in.yt-12 only)	
Voltage	230 V
Green / ground	P118
Black / line	K26-P
White / common	P124

Pump 1 (A3)	
Voltage	230 V
Green / ground	P49
Black / low speed	K2-P
Red / high-speed	K1-P
White / common	P58

Pump 3 (C3) (in.yt-7 and in.yt-12)	
Voltage	230 V
Green / ground	P94
Black / low speed	K22-P
Red / high-speed	K21-P
White / common	P88

Pump 5 (B3) (in.yt-12 only)	
Voltage	230 V
Green / ground	P115
Black / line	K24-P
White / common	P121

Ozonator (A1)	
Voltage	230 V
Green / ground	P52
Black / line	K4-P
White / common	P61

Pump 2 (A2)	
Voltage	230 V
Green / ground	P51
Black / low speed	K6-P
Red / high-speed	K3-P
White / common	P60

Pump 4 (B2) (in.yt-12 only)	
Voltage	230 V
Green / ground	P118
Black / low speed	K26-P
Red / high-speed	K27-P
White / common	P123

Circ. pump (C2) (in.yt-7 and in.yt-12)	
Voltage	230 V
Green / ground	P93
Black / line	K23-P
White / common	P87

Blower (B4) (in.yt-12 only)	
Voltage	230 V
Green / ground	P114
Black / line	K25-P
White / common	P120

Light (12 V AC, 1A Max.)	
Voltage	
Always on	P34
Relay	P35

This table shows typical connections. OEMs may have a different connection scheme.



in.ye 120 V and 240 V

These tabs require high-voltage accessories to have straight, non-insulated, female quick-connect terminals for all connections, including ground. Depending on where the connections are made on the in.ye pack PCB, 120 V and 240 V accessories are supported. Refer to the following tables for correct connections. Note that all female terminals must be correctly and completely seated on the PCB tab for proper current ratings.

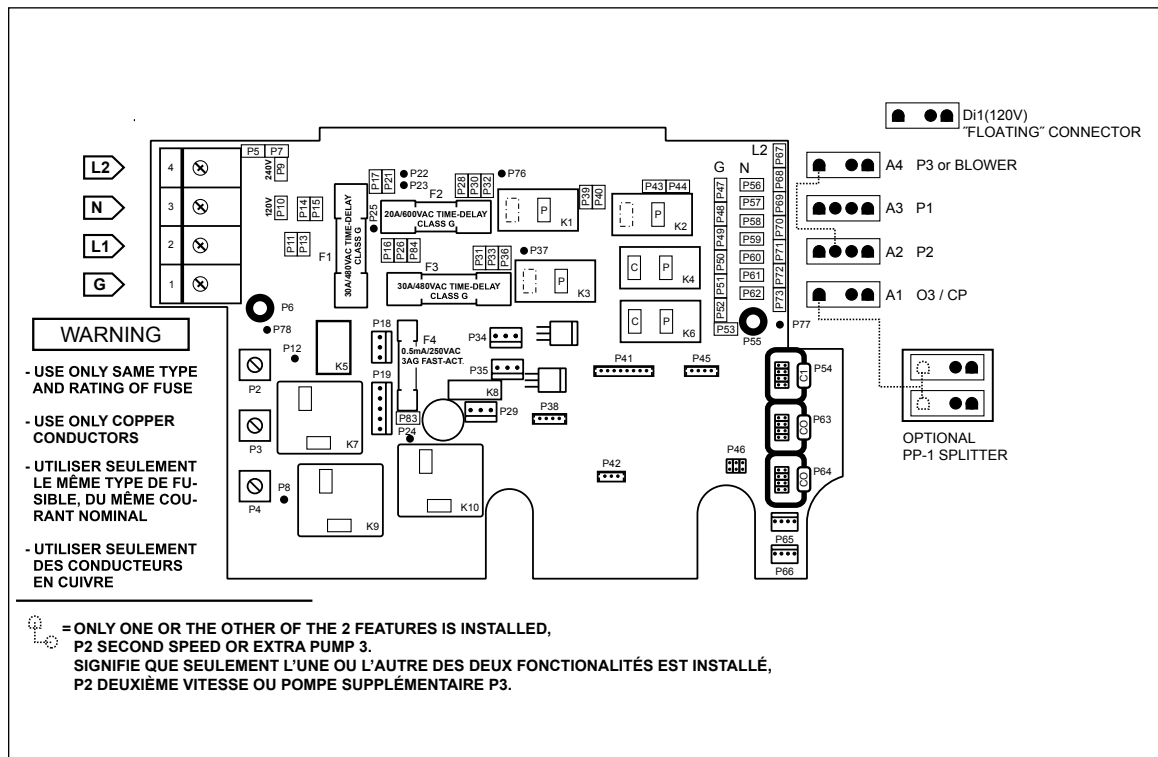

Direct output 1 (in.ye-5 ce only) (floating connector)		Pump 1 (A3)		Pump 3 (A4) (in.yt-5 ce only)		Ozonator* (A1)		
Voltage	120V	240V	Voltage	120V	240V	Voltage	120V	240V
Green / ground	P47	P47	Green / ground	P49	P49	Green / ground	P52	P52
Black / line	P32	P32	Black / low speed	K2-P	K2-P	Black / line	K1-P	K1-P
White / common	P56	P67	White / common	P58	P69	White / common	P61	P72

Pump 2 (A2)		Circ. pump* (A1)		Blower (A4) (in.ye-5 ce only)		Light (12 V AC, 1A Max.)		
Voltage	120V	240V	Voltage	120V	240V	Voltage		
Green / ground	P51	P51	Green / ground	P52	P52	Green / ground	P48	P48
Black / low speed	K6-P	K6-P	Black / line	K1-P	K1-P	Black / line	K6-P	K6-P
Red / high-speed	K3-P	K3-P	White / common	P61	P72	White / common	P57	P68
White / common	P60	P71				Always on	P34	
						Relay	P35	

* Ozonator and circ pump can be combined on the same output via the optional splitter PP1.

This table shows typical connections. OEMs may have a different connection scheme.



in.yt 120 V and 240 V

These tabs require high-voltage accessories to have straight, non-insulated, female quick-connect terminals for all connections, including ground. Depending on where the connections are made on the spa pack PCB, 120 V and 240 V accessories are supported. Refer to the following tables for correct connections. Note that all female terminals must be correctly and completely seated on the PCB tab for proper current ratings.

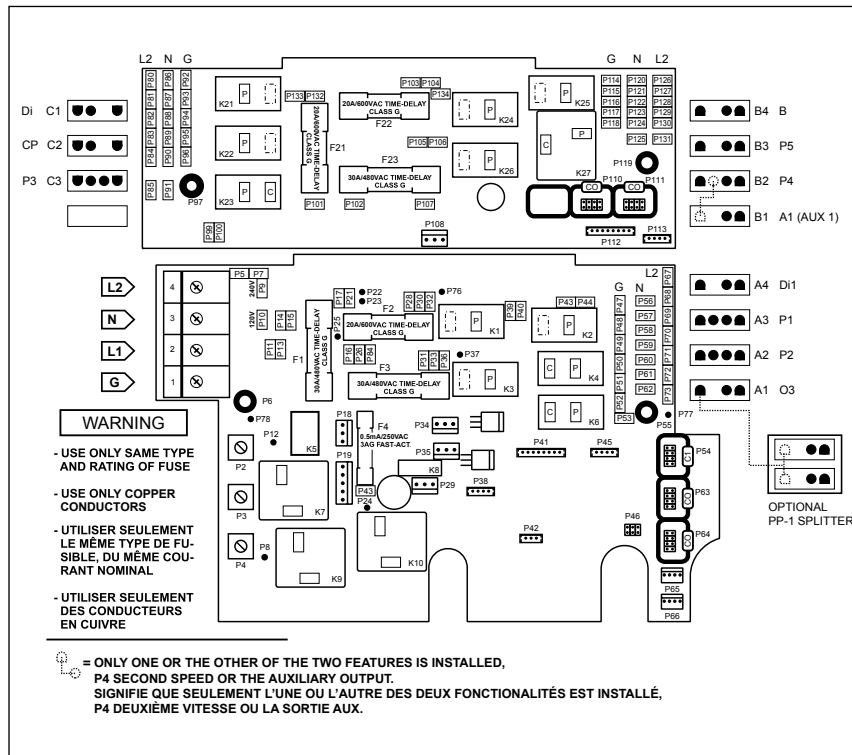

Direct output 1 (A4)

Voltage	120V	240V
Green / ground	P47	P47
Black / line	P32	P32
White / common	P56	P67

Direct output 2 (C1) (in.yt only)

Voltage	120V	240V
Green / ground	P92	P92
Black / line	PI33	PI33
White / common	P86	P80

Auxiliary (B1) (in.yt-12 only)

Voltage	120V	240V
Green / ground	PI18	PI18
Black / line	K26-P	K26-P
White / common	PI24	PI30

Pump 1 (A3)		
Voltage	120V	240V
Green / ground	P49	P49
Black / low speed	K2-P	K2-P
Red / high-speed	K4-P	K4-P
White / common	P58	P69

Pump 3 (C3) (in.yt-7 and in.yt-12)		
Voltage	120V	240V
Green / ground	P94	P94
Black / low speed	K22-P	K22-P
Red / high-speed	K21-P	K21-P
White / common	P88	P82

Pump 5 (B3) (in.yt-12 only)		
Voltage	120V	240V
Green / ground	PI15	PI15
Black / line	K24-P	K24-P
White / common	PI21	PI27

Ozonator (A1)		
Voltage	120V	240V
Green / ground	P52	P52
Black / line	K1-P	K1-P
White / common	P61	P72

Pump 2 (A2)		
Voltage	120V	240V
Green / ground	P51	P51
Black / low speed	K6-P	K6-P
Red / high-speed	K3-P	K3-P
White / common	P60	P71

Pump 4 (B2) (in.yt-12 only)		
Voltage	120V	240V
Green / ground	PI18	PI18
Black / low speed	K26-P	K26-P
Red / high-speed	K27-P	K27-P
White / common	PI23	PI29

Circ. pump (C2) (in.yt-7 and in.yt-12)		
Voltage	120V	240V
Green / ground	P93	P93
Black / line	K23-P	K23-P
White / common	P87	P81

Blower (B4) (in.yt-12 only)		
Voltage	120V	240V
Green / ground	PI14	PI14
Black / line	K25-P	K25-P
White / common	PI20	PI26

Light (12 V AC, 1A Max.)

Voltage	
Always on	P34
Relay	P35

This table shows typical connections. OEMs may have a different connection scheme.



In.k200 keypad overview



in.k200

Compact series of entry-level keypads that gives complete control to wet fingers!

The in.k200 is a compact keypad designed to be used with Aeware's Y Series spa systems.

This new series of entry-level keypads comes in a waterproof plastic enclosure and is available in single pump, dual pump; dual pump/blower, or pump/blower configurations.

Easy to install, in.k200 comes with an in.link connector.

Note: The Y Series spa control is also compatible with the following keypads: in.k400, in.k450, in.k600 (streamlined). In.k19, in.k35 and in.k8 (with in.link connector).

Note: The following instructions are generic and provide a quick overview of the main functions. Please refer to your own QRC for specific functions.



Function description

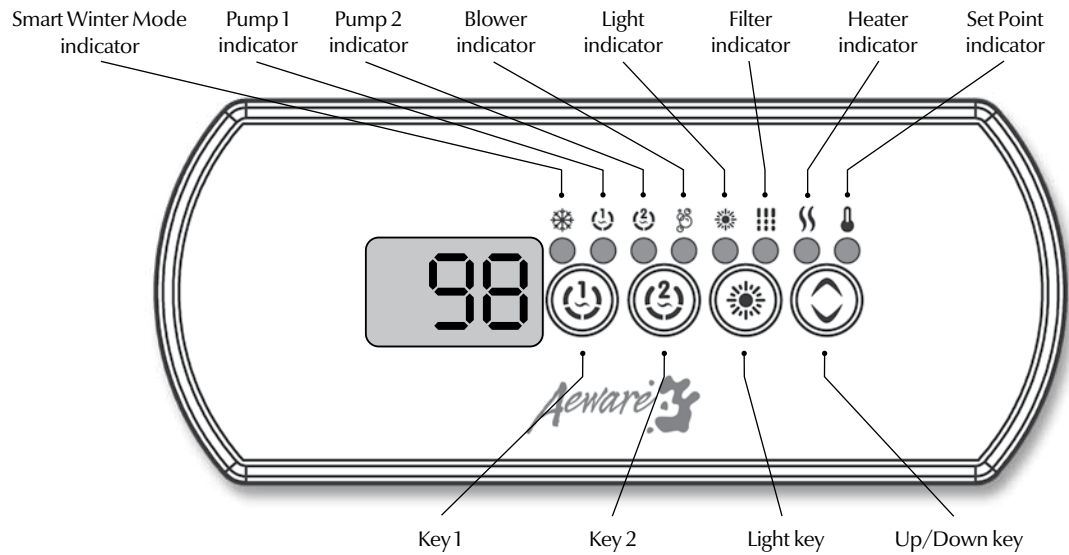

Instructions

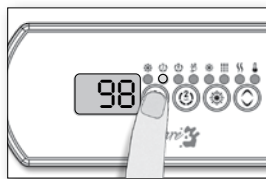

Key 1

Press **Key 1** to turn Pump 1 on at low speed. Press a second time to turn pump to high speed (with a dual-speed pump). A third time turns pump off.

A built-in timer automatically turns pump off after a predetermined period of time, unless it has been manually deactivated.

The *Pump 1* indicator lights up when Pump 1 is on. With dual-speed pump, the indicator will flash when Pump 1 is on at low speed.

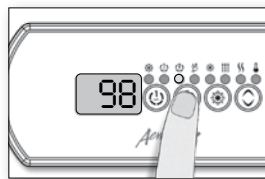

Key 2 (single pump or blower)

Press **Key 2** to turn Pump 2 or Blower on. Press a second time to turn pump or blower off.

A built-in timer automatically turns pump off after a predetermined period of time, unless it has been manually deactivated.

The *Pump 2* and/or *Blower* indicator lights up when the corresponding output is on.

Note: with dual-speed pump, the indicator will flash when Pump 2 is on at low speed.

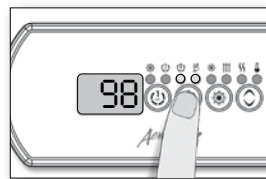

Key 2 (single pump & blower)

Press **Key 2** to turn Pump 2 on at high speed. Pressing a second time turns blower on. A third press turns Pump 2 off but leaves blower on. A final press turns blower off.

A built-in timer automatically turns pump/blower off after a predetermined period of time, unless it has been manually deactivated.

The *Pump 2* and/or *Blower* indicator lights up when the corresponding output is on.

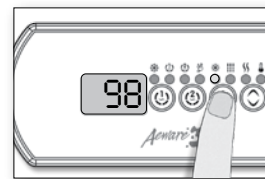

Light key

Press **Light** key to turn light on. Press **Light** key a second time to turn light off.

A built-in timer automatically turns light off after a predetermined period of time, unless it has been manually deactivated.

The *Light* indicator lights up when light is on.

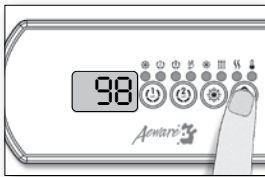

Up/Down key

Use **Up** or **Down** key to set desired water temperature. The temperature setting will be displayed for 5 seconds to confirm your new selection.

The *Set Point* indicator indicates that the display shows the desired temperature, NOT the current water temperature!

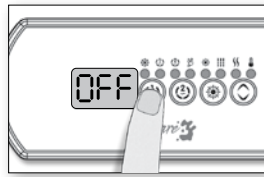

Off Mode

This mode allows you to stop all outputs for 30 minutes to perform a quick spa maintenance.

Press and hold **Key 1** for 5 sec. to activate the Off mode. Quick press **Key 1** to reactivate the system before the expiration of the 30 minute delay.

While the Off mode is engaged, the display will toggle between **OFF** and the water temperature.

Programming the system

Depending on system configuration the system performs either purge cycles or filter cycles.

Programming filter cycles

To program the filter cycles, you must enter the duration and frequency. During a filter cycle, pumps & blower run at high speed for one minute to purge the plumbing. Pump 1 or CP then runs at low speed for the remainder of the cycle.

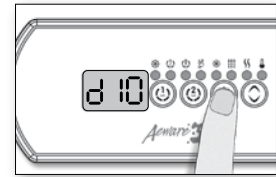

Setting filter cycle duration

Press and hold **Prog** or **Light** key until the display shows **dxx**, with "xx" representing the duration in hours.

Use **Up** or **Down** key to change setting.

0 = no filtration
24 = continuous filtration

Note: it's not recommended to set this to "0".

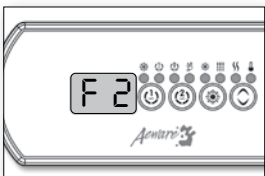

Filter cycle frequency

Press **Prog** or **Light** key again. The display will show **Fx**, with "x" representing the number of filter cycles per day (up to 4).

Use **Up** or **Down** key to change setting.

When the desired setting is displayed, press **Light** key to confirm. A filter cycle will start immediately.

The *Filter* indicator lights up when a filter cycle is on.

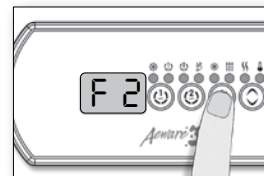

Programming purge cycles

To program the purge cycles, you must select the frequency. During a purge cycle, all pumps and the blower run for one minute.

Purge cycle frequency

Press and hold **Light** key until the display shows **Fx**, with "x" representing the number of purge cycles per day (up to 4).

Use **Up** or **Down** key to change setting.

When the desired setting is displayed, press **Light** key to confirm. A purge cycle will start immediately.

The *Filter* indicator lights up when a purge cycle is on.

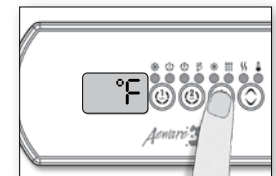

Setting the temperature display units

Quick press **Light** key again. The display will show either °F or °C.

Use **Up** or **Down** key to change units.

Press **Light** key a last time to go back to normal mode.

°F = Fahrenheit
°C = Celsius

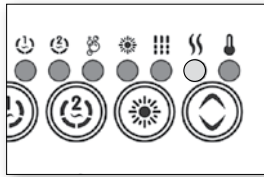

Water temperature regulation

In a regulation cycle, the system first generates water flow through the heater housing and the plumbing, in order to ensure accurate water temperature readings as well as avoiding heater activation in dry conditions.

The system verifies periodically that all parameters are within normal range.

If the readings received from the system are not valid, blanks (- -) will be displayed until normal readings have been successfully found.

After verifying pump activation and taking a water temperature reading if required, the system automatically turns the heater on to reach and maintain water temperature at Set Point. The *Heater* indicator lights up when the heater is on. It flashes when there is a request for more heat but the heater has not yet started.

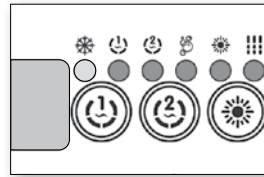

Smart Winter Mode

Our Smart Winter Mode protects your system from the cold by turning pumps on several times a day to prevent water from freezing in pipes. The *Smart Winter Mode* indicator lights up when the Smart Winter Mode is on.

Cool down

After heating the spa water to the desired Set Point, the heater is turned off, but its associated pump (Pump 1 low-speed or CP) remains on for a certain amount of time to ensure adequate cooling of the heating element, prolonging its life.

The *Heater* icon flashes during this time.

Typical settings

Adjustable Regulating Set Point:	59°F (15°C) to 104°F (40°C)
Factory Default Set Point:	Typical 95°F (35°C) / Max 100°F (38°C)
Filter Cycle Duration:	0 to 24 hrs / Factory set at 2hrs
Filter Cycle Frequency:	1 to 4 times a day / Factory set at 2
Filter Cycle Start:	00:00 to 23:59 / Factory set at 12:00
Pump Runtime:	1 to 255 min. / Factory set at 20 min.
Light Timeout:	1 to 255 min. / Factory set at 120 min.

Keypads available for the Y Series:



in.k19



in.k35



in.k200 (LED display, 4 keys, 8 light indicators)



in.k600 (streamlined)

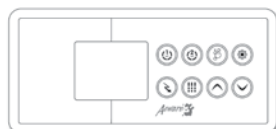

in.k4



in.k8



in.k450 (LCD display, 6 keys, 10 function icons)

Y Series error codes

Y Series error codes summary

Error codes indicate a failure condition or a problem which needs to be corrected to ensure proper functioning of the system. Both the error code and the water temperature are alternatively displayed.

All errors codes will be displayed on the keypad display.

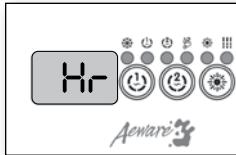

Hr
An internal hardware error has been detected in the spa pack.

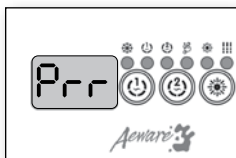

Prr
The Prr error message indicates a problem with the regulation probe. The system is constantly verifying if temperature probe reading is within normal limits.

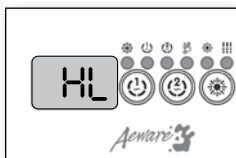

HL
Water temperature at the heater has reached 119°F.
Do not enter spa water!



FLO
The system did not detect any water flow while the main pump was running.



UPL
No low-level configuration software has been downloaded into the system.



AOH
Temperature inside the spa skirt is too high, causing the internal temperature in the spa pack to go above normal limits.



OH
Water temperature in the spa has reached 108°F.
Do not enter spa water!



Hr error message / flow chart & step-by-step

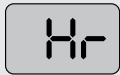

An internal hardware error has been detected

Flow chart

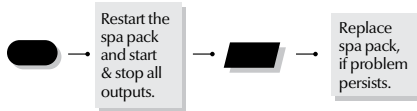

Step-by-Step

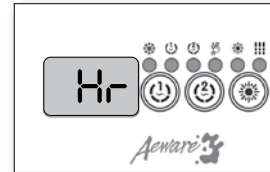

- Restart the spa pack and start & stop all pumps and blower.
- If error reappears, replace the spa pack.

Prr error message / flow chart & step-by-step



Regulation probe issue

Flow chart

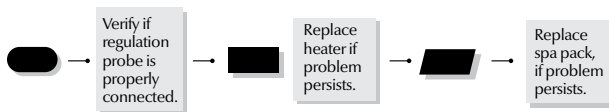

Step-by-Step

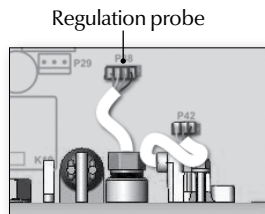
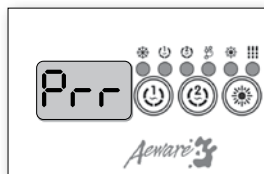

- Verify if regulation probe (located above the heater) is properly connected.
- Replace heater if problem persists.
- Replace spa pack, if problem persists.



HL error message / flow chart & step-by-step

HL The system has shut down because the temperature at the heater has reached 119°F (48°C).

Flow chart

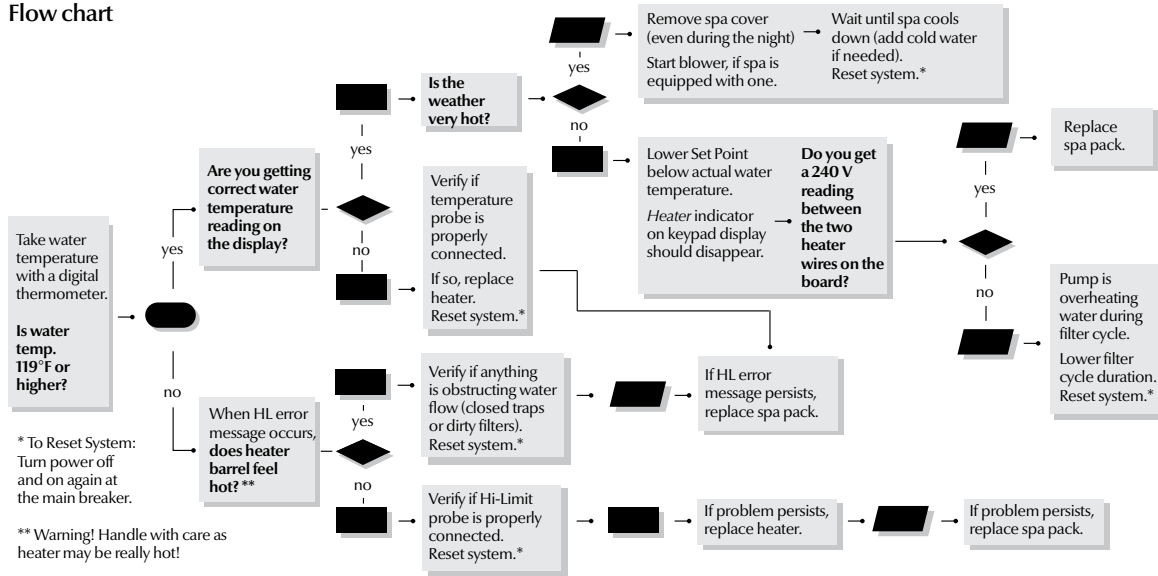

Step-by-Step

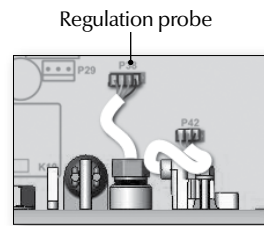

HL
Water temperature at the heater has reached 119°F

1. Measure the temperature with a DIGITAL thermometer and compare its reading with temp. on the display. Make sure the temp. reading is lower than 119°F.
 - Shut power off and power the spa up again to reset the system.
 - If HL error persists, replace heater.
 - If HL error persists, replace spa pack.
2. If reading is below 119°F:
 - Carefully check if heater barrel feels hot. If it's hot, verify if anything is obstructing water flow (closed valves or dirty filter).
 - Shut power off and power the spa up again to reset the system.
 - If HL error persists, replace heater.
 - If HL error persists, replace spa pack.
3. If reading is 119°F or higher:
 - Verify if the Temp. & High Limit probes are properly connected.
 - Shut power off and power the spa up again to reset the system.
 - If problem persists, replace heater.
 - If problem persists, replace spa pack.

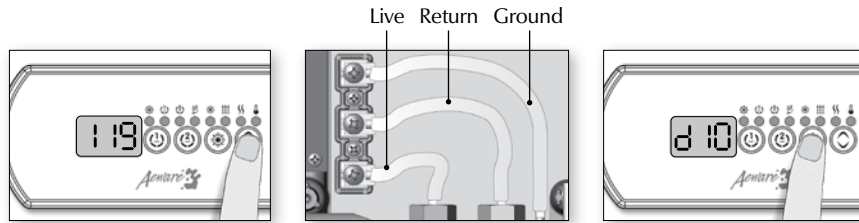

If weather is very hot:

1. Remove spa cover (even during the night). Start blower if spa is equipped with one. Wait until spa cools down (add cold water if necessary).

- Shut power off and power the spa up again to reset the system.

If hot weather is not a factor:

2. Lower Set Point below current water temperature.

The *Heater* indicator should disappear from keypad display.

To shorten filter cycle duration:

3. With a voltmeter, read voltage between the live and ground heater terminals.
4. If you do read 240 V, replace spa pack.
5. If you do not read 240 V, pump may be overheating water during filter cycle.

Shorten filter cycle duration.

To shorten filter cycle duration:

6. Press and hold the **Light** key for 5 seconds. Display will show a value that represents the filter cycle duration in hours.
7. Use the **Down** arrow key to lower the number of hours.
0 = no filtration
12 = continuous filtration

When the desired setting is displayed, press **Light** key again. The filter cycle will start immediately.



FLO & UPL error message / flow chart & step-by-step

FLO The system did not detect any water flow while the primary pump was running. Follow the troubleshooting flow chart below to identify the problem:

Make sure that the low-level programming has been properly set, with or without circulation pump (depending on your system configuration).

Flow chart

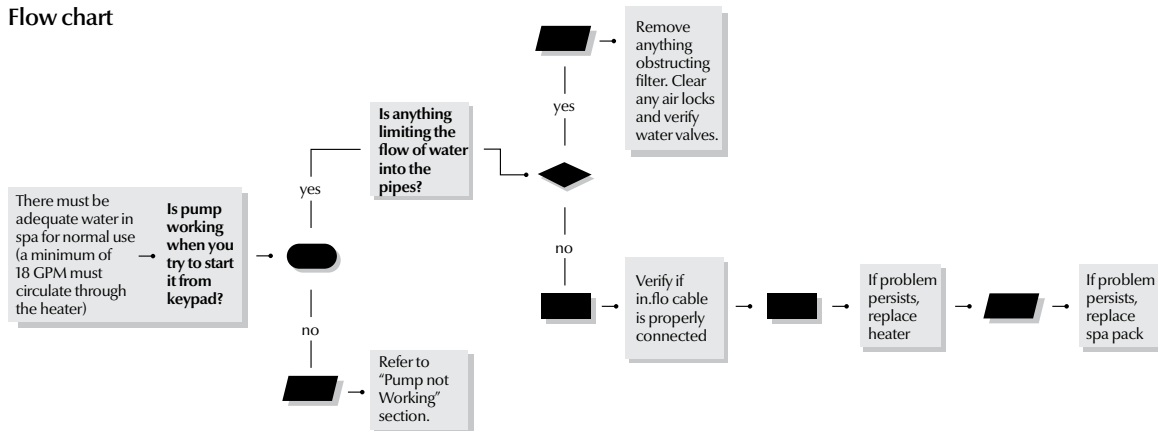

Step-by-Step

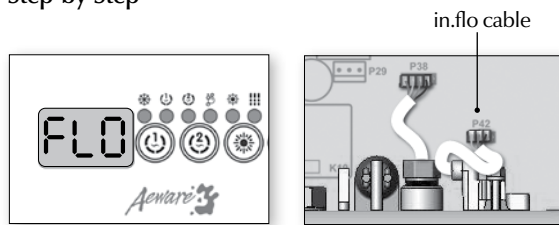

UPL No low-level configuration software in system!

Step-by-Step



FLO
Primary pump is activated, but the system doesn't detect any water flow

- Make sure water valves are open and that water level is high enough.
- Check and remove anything obstructing the filter.
- Make sure there are no air locks (or that no object obstructs the passage of water in the heater channel). Pumps may make strange noises. Follow air lock procedure to clear them.
- Make sure that the pump associated to the heater (primary pump) is running.
- Make sure the in.flo cable (located above the heater) is properly connected.
- If problem persists replace heater.
- If the problem is not solved replace the spa pack.

- New low-level configuration software needs to be downloaded into the spa system; without it the system will not be operable.
- Contact our toll free line for technical support (1-800-784-3256).
Note: this line is dedicated to assist authorized service technicians and dealers only.



OH error message / flow chart & step-by-step

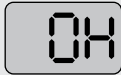

Water temp. in the spa has reached 108°F

Flow chart

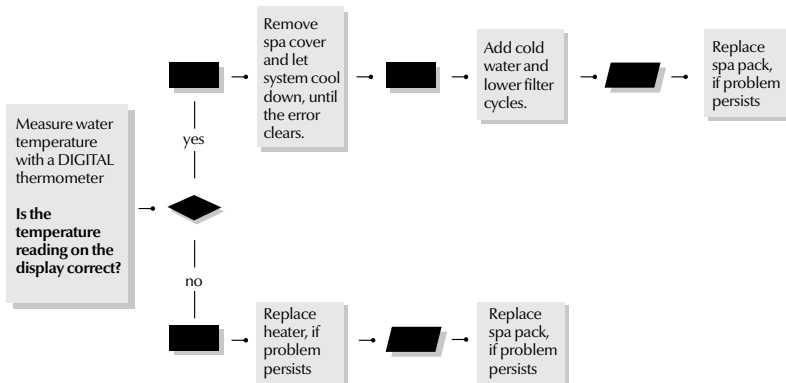

Step-by-Step



- Measure water temperature with a DIGITAL thermometer and compare its reading with temp. on the display. If temp. reading is different, replace heater.
- Remove spa cover and let spa cool down.
- Add cold water and lower filter cycles.
- If problem persists replace spa pack.



Troubleshooting

Pump 1 doesn't work / flow chart & step-by-step

If Pump 1 is not working, follow this troubleshooting flow chart:

Flow chart

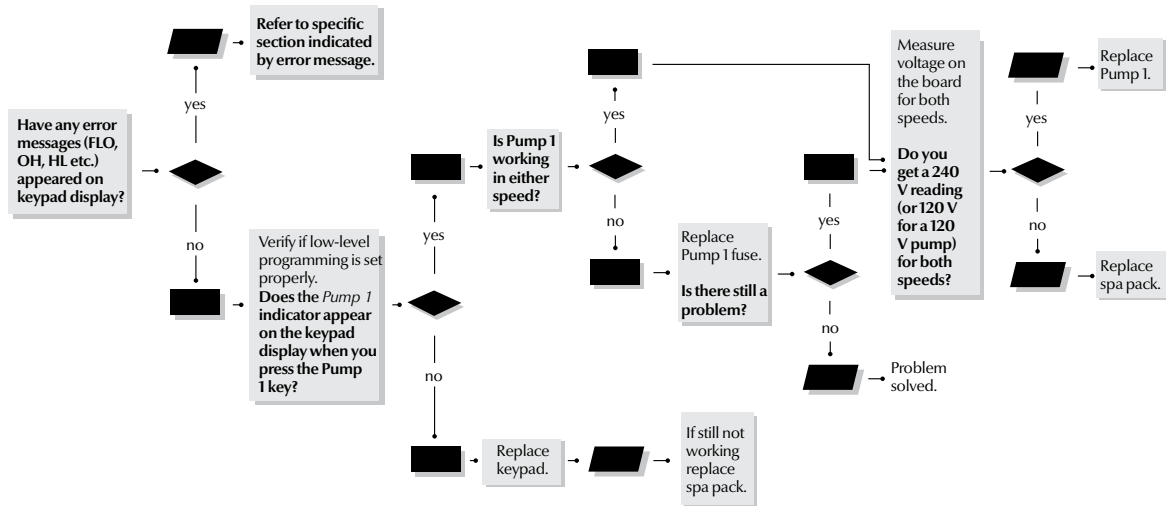

Step-by-Step

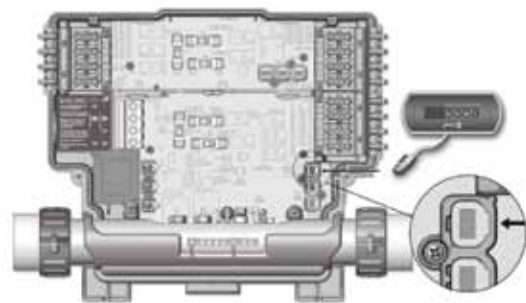
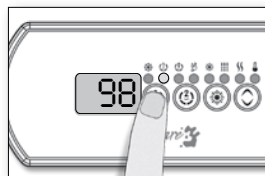

Pump 1 does not work!

- Check for an error message on keypad display. If there is one, refer to the specific section indicated by the error message.
- Verify low-level programming configuration.
- Verify if the *Pump 1* indicator appears on keypad display when you press **Key 1**.
- If the *Pump 1* indicator does not appear, use a spare keypad to verify if keypad is defective.
If it is, replace keypad.
If not, replace spa pack.
- If *Pump 1* indicator appears when **Key 1** is pressed, verify if pump works in either speed.

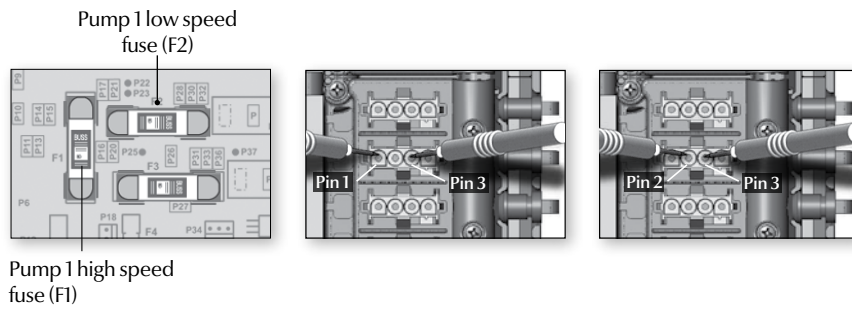

- If Pump 1 does not work in either speed, replace appropriate Pump 1 fuse.
- If replacing the fuse is not effective or if Pump 1 works in only one speed, take voltage reading on the corresponding in.link connector.

- Turn Pump 1 to **high speed** and take voltage reading between:
Pin 1 & Pin 3
Your reading should be:
240 V for a 240 V pump
120 V for a 120 V pump

- Turn Pump 1 to **low speed** and take voltage reading between:
Pin 2 & Pin 3
Your reading should be:
240 V for a 240 V pump
120 V for a 120 V pump

- If voltage is as it should be, replace Pump 1.
- If not, replace spa pack.



Pump 2 or blower doesn't work / flow chart & step-by-step

If Pump 2 or blower is not working, follow this troubleshooting flow chart:

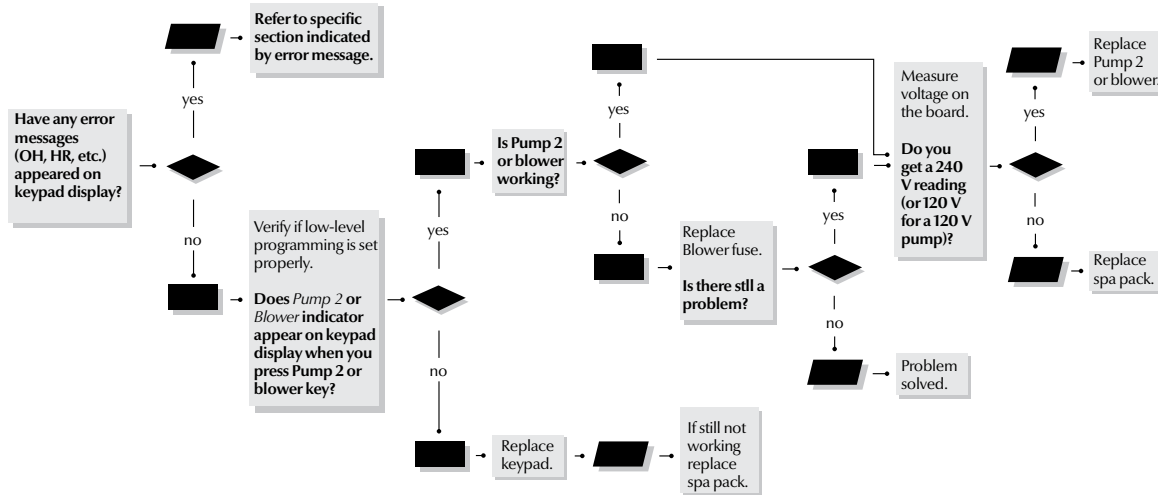

Step-by-Step

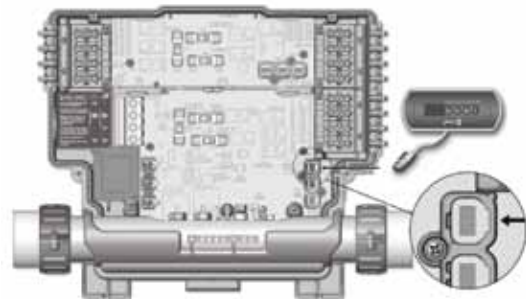
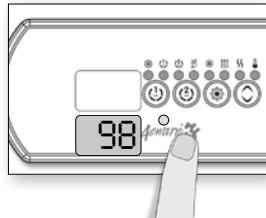

Pump 2 or blower is not working!

- Check for an error message on keypad display. If there is one, refer to the specific section indicated by the error message.
- Verify low-level programming configuration.
- Verify if *Pump 2* or *Blower* indicator appears on keypad display when you press **Key 2** button.
- If *Pump 2* or *Blower* indicators do not appear, use a spare keypad to verify if keypad is defective.
If it is, replace keypad.
If not, replace spa pack.
- If *Pump 2* indicator appears when **Key 2** is pressed, verify if pump works in either speed (if dual speed pump).

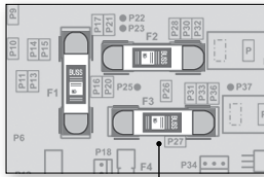

Pump 2 fuse (F3)

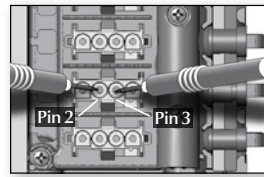
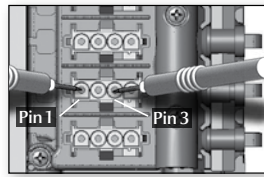

- If Pump 2 does not work in either speed, replace Pump 2 fuse.
- If replacing the fuse is not effective or if Pump 2 works in only one speed, take voltage reading on the corresponding in.link connector.

- Turn Pump 2 to **high speed** and take voltage reading between:

Pin 1 & Pin 3

Your reading should be:

240 V for a
240 V pump

120 V for a
120 V pump

- Turn Pump 2 to **low speed** and take voltage reading between:

Pin 2 & Pin 3

Your reading should be:

240 V for a
240 V pump

120 V for a
120 V pump

- If voltage is as it should be, replace Pump 2.
- If not, replace spa pack.



Circulation pump doesn't work / flow chart & step-by-step

If circulation pump is not working, follow this troubleshooting flow chart:

Flow chart

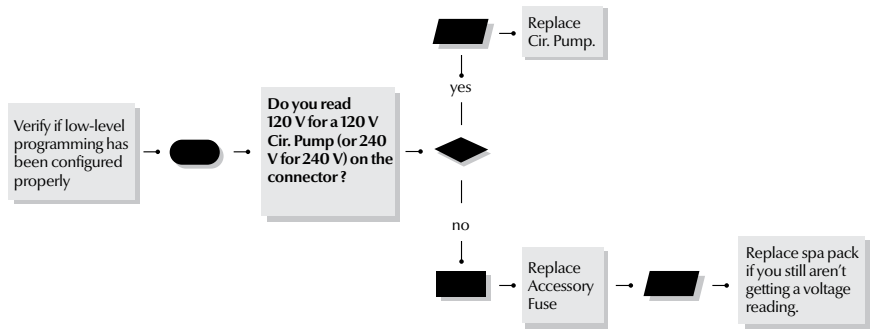

Step-by-Step

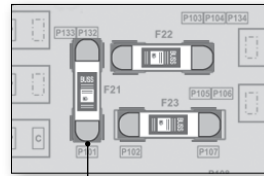
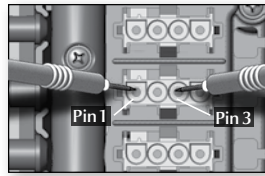
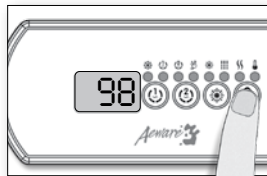

Circulation pump fuse (F21)

If circulation pump is not working:

- Verify low-level programming configuration.
- Start circulation pump by setting temperature set point 2 °F higher than actual water temperature.
- Take voltage reading on the corresponding MP connector:
 Pin 1 & Pin 3
 Your reading should be:
 240 V for a 240 V pump
 120 V for a 120 V pump
- If you don't get a voltage reading, replace the accessory fuse.
- If changing the fuse does not fix the problem, replace the spa pack.
- If voltage is as it should be, replace circulation pump.



Ozonator doesn't work / flow chart & step-by-step

If the ozonator is not working, follow this troubleshooting flow chart:

Ozonator output will be shut down when Pump 1, Pump 2 or blower have been turned on manually.

Flow chart

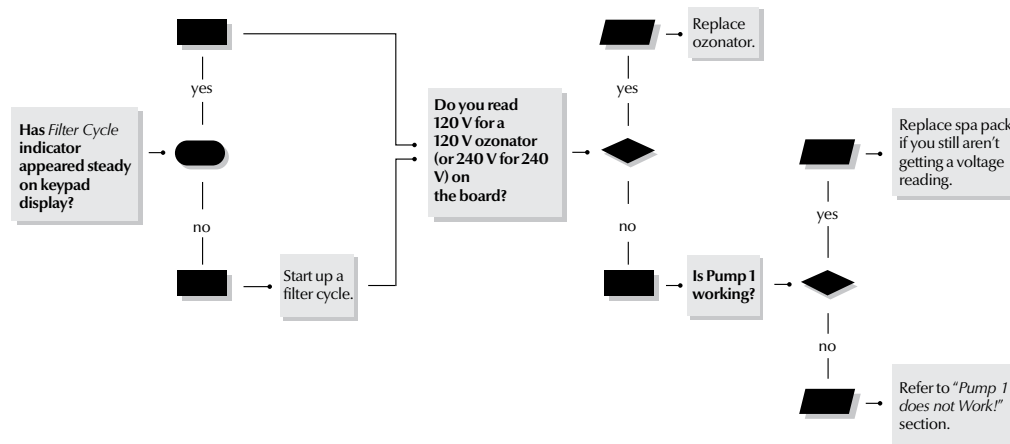

Step-by-Step

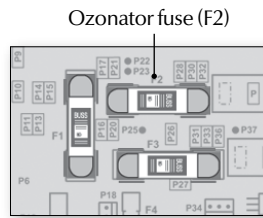
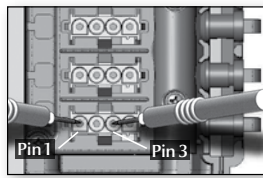
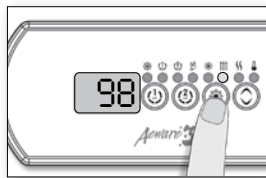

If the ozonator is not working:

- Check if *Filter Cycle* indicator appears steady on keypad.
- If the filter indicator is blinking it indicates that the filter cycle has been interrupted. In that case, reset the breaker by turning the power off and on again to resume cycle.
- If not, start up a filter cycle (see *Programming Filter Cycles* section).
- If ozonator does not work even when filter cycle indicator is on, take voltage reading on the corresponding AMP connector:
 Pin 1 & Pin 3
 Your reading should be:
 240 V for a 240 V pump
 120 V for a 120 V pump
- If you don't get a voltage reading, replace the accessory fuse.
- If changing the fuse does not fix the problem, replace the spa pack.
- If voltage is as it should be, replace ozonator.



Nothing seems to work / flow chart & step-by-step

If nothing seems to work, turn off the main breaker and visually inspect power input cable, gently pulling on it to make sure is properly tightened. Turn the main breaker back on and follow this troubleshooting flow chart:

Flow chart For North American systems

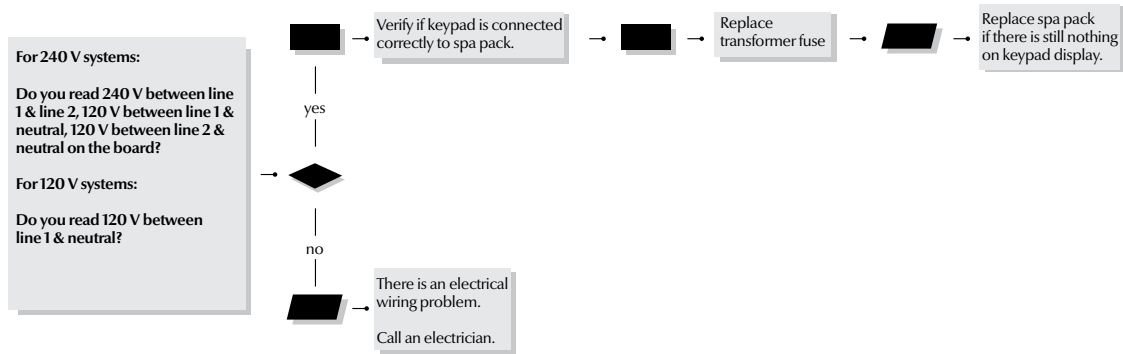

Step-by-Step

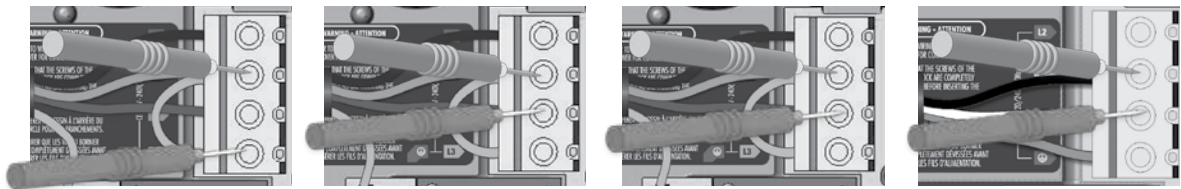

Nothing seems to work!

- Verify that all screws are properly tightened on the terminal block. Turn power off and make sure that all cables hold firmly in the terminal block if you pull on them. Once done, turn power back on.
- On the terminal block, measure voltage between line 1 and line 2.
- You should get 240 V.

- Measure voltage between line 1 and neutral.
- You should get 120 V.

- Measure voltage between line 2 and neutral.
- You should get 120 V.
- If you do not get good readings, this indicates an electrical wiring problem.

Call an electrician!

For 120 V systems

- Measure voltage between line 1 and neutral.
- You should get 120 V.
- If you do not get good readings, this indicates an electrical wiring problem.

Call an electrician!



Nothing seems to work / flow chart & step-by-step

If nothing seems to work, turn off the main breaker and visually inspect power input cable, gently pulling on it to make sure is properly tightened. Turn the main breaker back on and follow this troubleshooting flow chart:

Flow chart For European systems

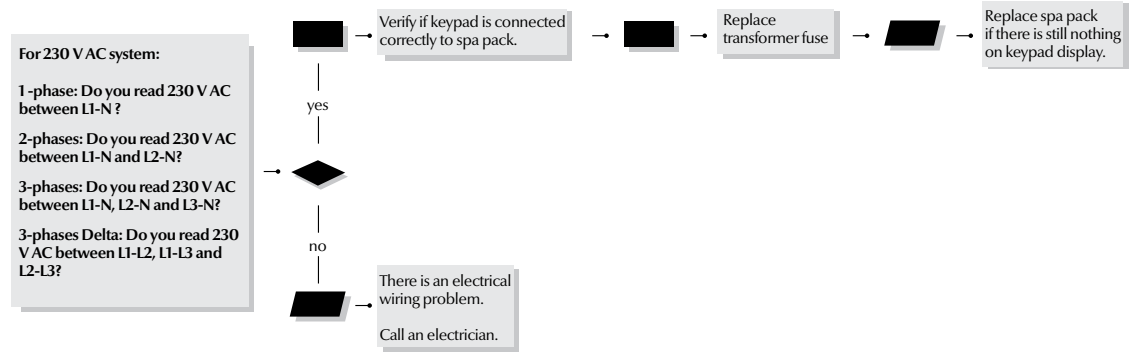



Step-by-Step

Nothing seems to work!

Verify that all screws are properly tightened on the terminal block. Turn power off and make sure that all cables hold firmly in the terminal block if you pull on them. Once done, turn power back on.

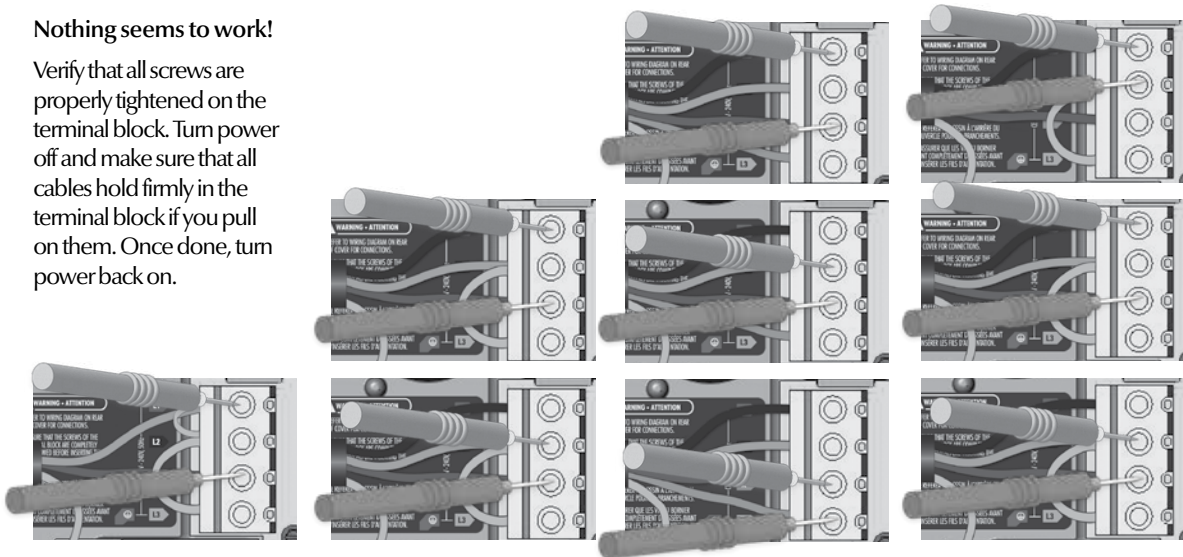

For 1-phase system

- On the terminal block, measure voltage between line 1 and neutral.
- You should get 230 V AC.
- If you do not get good readings, this indicates an electrical wiring problem.

Call an electrician!

For 2-phase system

- Measure voltage between line 1 and neutral and between line 2 and neutral.
- You should get 230 V AC on both readings.
- If you do not get good readings, this indicates an electrical wiring problem.

Call an electrician!

For 3-phase system

- Measure voltage between line 1 and neutral, between line 2 and neutral and between line 3 and neutral.
- You should get 230 V AC for each reading.
- If you do not get good readings, this indicates an electrical wiring problem.

Call an electrician!

For 3-phase Delta system

- Measure voltage between line 1 and line 2, between line 1 and line 3 and between line 2 and line 3.
- You should get 230 V AC for each reading.
- If you do not get good readings, this indicates an electrical wiring problem.

Call an electrician!

If the voltage reading are OK then:

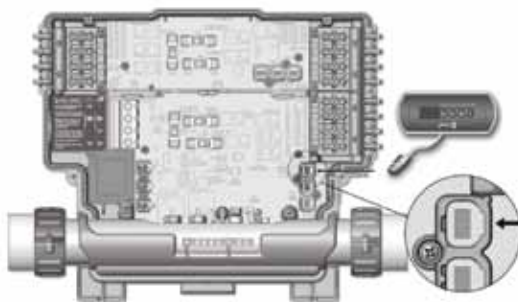

- Verify if keypad is correctly connected to the spa pack.

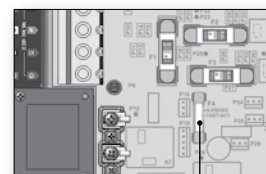

Transformer fuse

- Verify the transformer fuse.
- Replace transformer fuse if necessary.
- If problem persists, replace spa pack.

Spa not heating / flow chart & step-by-step

If spa is not heating, follow this troubleshooting flow chart:

Flow chart

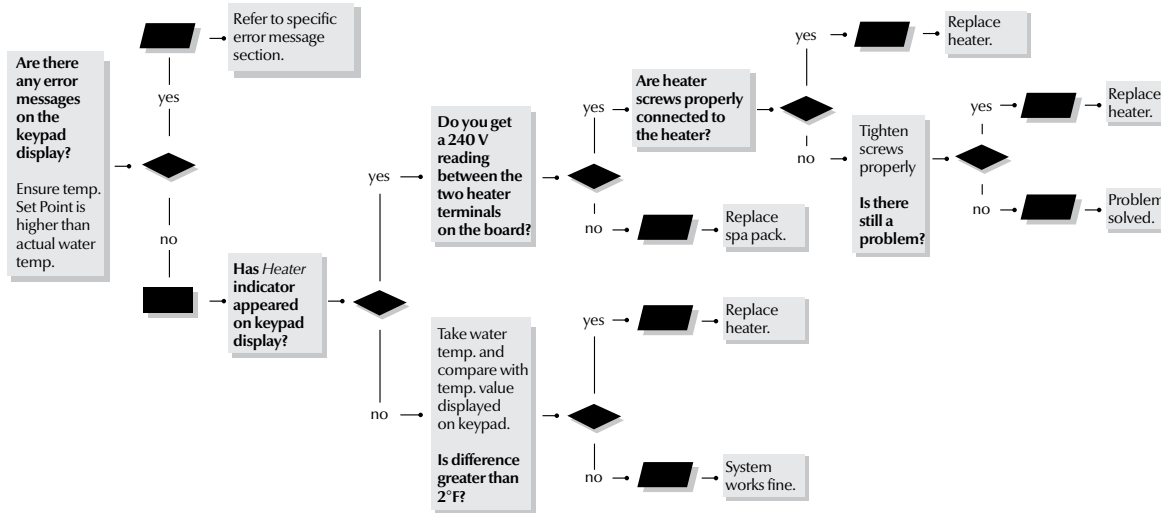

Set Point indicator

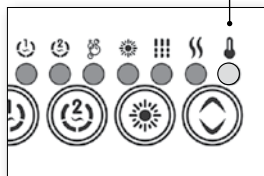

Heater indicator

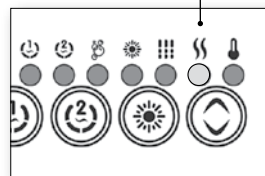

Live Return Ground

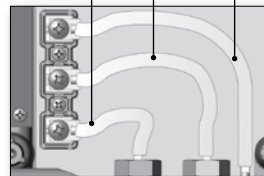

Spa not heating!

- Check for an error message on keypad display. If there is one, refer to specific section indicated by the error message.
- If there is no error message, try to raise water temperature by increasing the Set Point 2°F higher than actual water temperature. Press **Up** key to increase Set Point.
- Verify if *Heater* indicator appears on keypad display.
- The heater indicator will be on when heater is on. It will flash if more heat has been requested, but heater has not started yet.
- If heater indicator lights up on the display, take voltage reading between the heater live and return terminals.
- If voltage reading is not as it should be, verify if heater terminals are properly connected .
- If it is, replace spa pack.
- In the case of the European model in.yt.ce only, replace accessory fuse.
- If problem persists, replace spa pack.

Your reading should be:

240 V: for 240 V heaters
120 V: for 120 V heaters



Keypad doesn't seem to work step-by-step

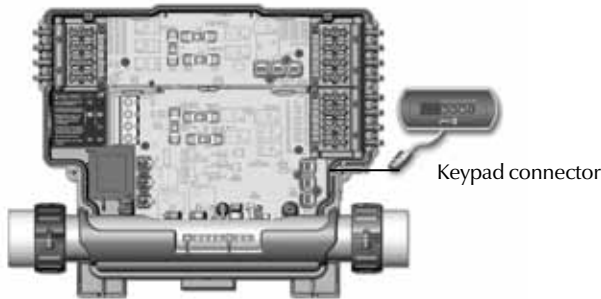

If a keypad doesn't work:

- Verify keypad connections and try spare keypad.
- Replace keypad if problem is corrected.
- Replace pack if problem is not corrected.

GFCI trips

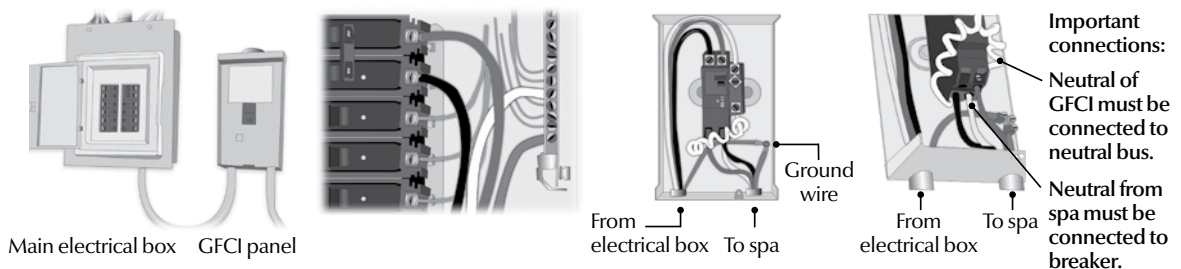

Warning!
Total current output cannot exceed total current input rating!
 There are different GFCI models used on the market. See manufacturer's instructions that come with the GFCI for specific information. Note that all illustrations are examples only.

If the GFCI is properly connected but still tripping, unplug all outputs from the spa pack (pumps, blower, heater, ozonator etc).

Reconnect one output at a time until the GFCI trips again.

Replace defective component.

Note: Incorrect GFCI wiring may lead to a condition where the GFCI may NOT trip when it should, causing electrical shock hazard. All electrical installations should be done by qualified personnel only.

Verify that GFCI is properly connected.

If it's not, verify GFCI diagram and reconnect it.

Verify the spa pack wiring (make sure that the neutral and the ground have not been inverted).



Step-by-step field replacement procedure

Y Series

Step-by-step field replacement procedure

As part of our technical support services, this section provides proper step-by-step methods to facilitate the replacement of Y Series spa packs in the field.

Tools needed:

- Phillips & flat screwdrivers
- Multimeter
- Open-ended adjustable wrench
- Scraper tool
- Pliers
- GFCI tester

All procedures described in this service manual must only be performed by qualified personnel, in accordance with the standards applicable in the country of installation.

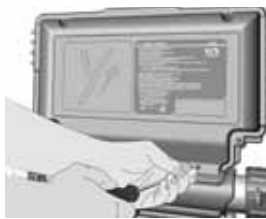
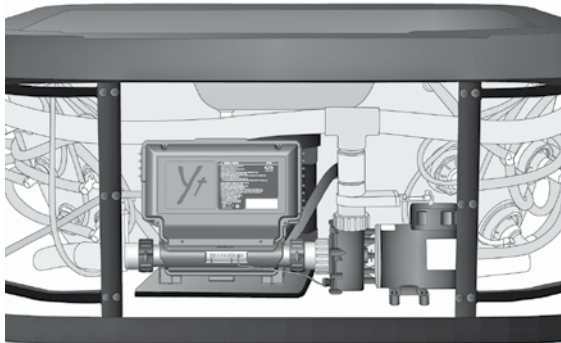

⚠ Warning!

When replacing a Y Series spa pack, it's very important to make sure to turn power off before proceeding.

With a Phillips screwdriver loosen the screws of the spa pack cover and remove it.

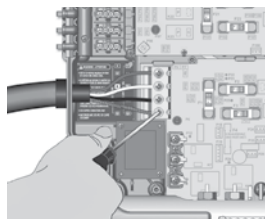

Disconnect incoming power lines by loosening the screws on the terminals of the terminal block.

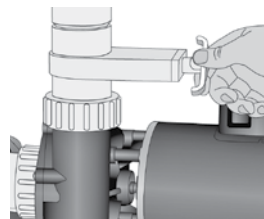

Carefully revise the spa plumbing schematics and identify the spa **Flow Shut Off Valves**. Make sure that both **Flow Shut Off Valves**, which control water inlet before and after the heater, are closed.

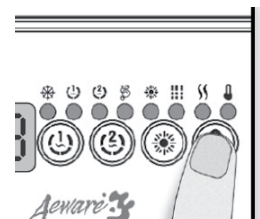

With a Phillips screwdriver loosen the screws of the strain reliefs and remove them. Unplug all accessory outputs. e.g.: Pumps, Blower or any other accessories.

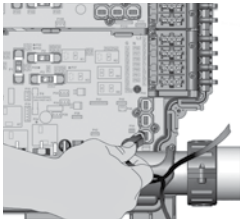

Unplug all low-voltage outputs. e.g.: main keypad, light or any other accessory.

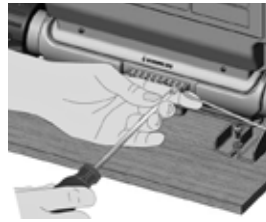

Disconnect the grounding cable from the bonding lug of the spa pack.

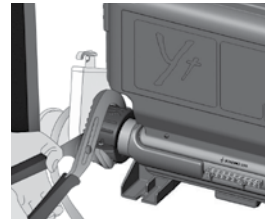

Using an open-ended adjustable wrench loosen both 2" plastic nuts at each end of the unit's heater, as illustrated.

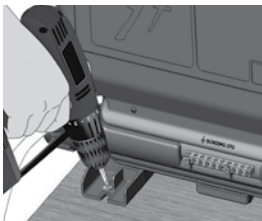
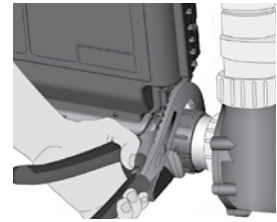

Remove the 2 screws that hold the front of the unit's feet attached to the spa floor.

Note: the unit can also be wall-mounted. For more details on wall installation procedure refer to the wall installation section of the techbook.

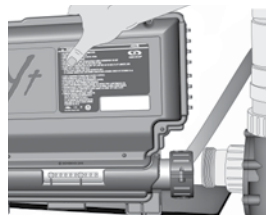

Release the 2" heater nuts from both ends of the spa piping. Release the spa pack by sliding the unit away from the guide plate that holds the backside of the unit's feet in place. If the spa pack does not have a guide plate please refer to the installation section of the techbook for more details.

Remove the defective spa pack unit from the spa.

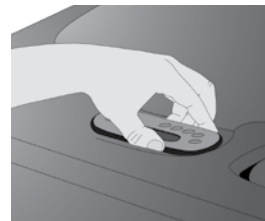

Once that is done, remove the old keypad from the spa.

Note: the procedure on keypad replacement shown here is for educational purposes only. It is not always necessary to replace the keypad, unless it may be the cause of the malfunctioning of the system. Common sense should prevail.

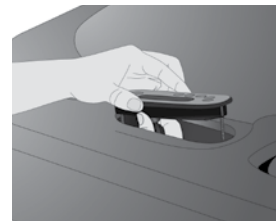

When removing the old keypad, make sure to note the exact model, available options etc. Ideally, the new replacement keypad should be of the exact same model as the old one.

If it's not, contact our Technical Support Department for keypad compatibility list.

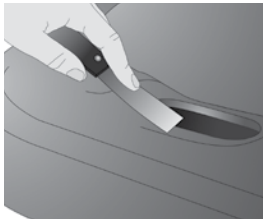

With a scraper tool, gently clean the installation surface of the new keypad, then use an alcohol saturated paper towel to remove any unwanted residue left over from the old keypad.



Feed the cable of the new keypad through the hole opening in the spa.

Orient the cable's connector towards the spa pack to facilitate its connection later.



Insert the keypad in the opening.



Peel off the protective layer from the adhesive on the back of the keypad.

Make sure that the keypad is well aligned and rests perfectly in the recess of the spa.



Secure the keypad in place. Ensure that its adhesive strip is properly glued by pressing evenly with your finger over the entire surface.

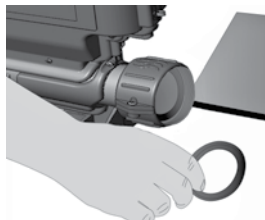

Place a rubber 2" O-ring gasket at the end of each heater nut, to prevent water leakage between the heater nuts and the 2" PVC heater tailpieces.

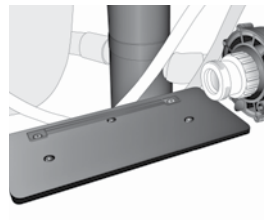

When installing the new spa pack, slide the back side of the unit's feet into the guide plate.

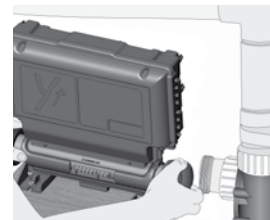

Install the new spa pack in the spa plumbing.

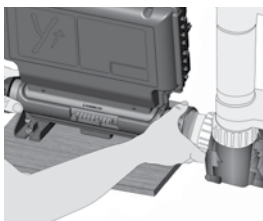

Screw fittings to join to the spa pipe system, making sure that the piping and nut threads are not over-tightened.

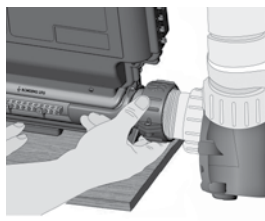

Use an open-ended wrench to tighten both 2" plastic nuts at each end of the unit's heater.

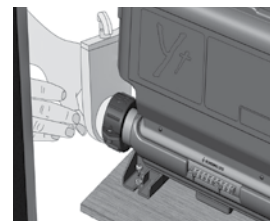
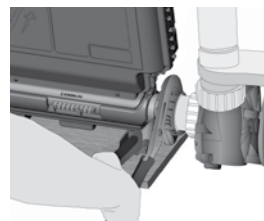

Finally, reopen both flow shut off valves and verify for leaks.



How to replace the heater

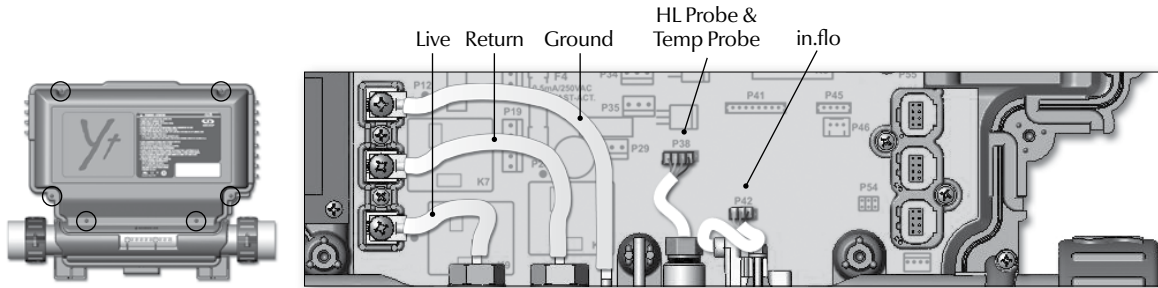

Using a Phillips screwdriver, loosen the 4 or 6 screws that hold the cover in place. Use a Phillips screwdriver to loosen the terminals and remove all electrical heater connections: Return, Live and Ground. Manually remove the HL probe & Temp. probe connector.

Manually remove in.flo connector. Be careful not to damage any connector by twisting or pulling too hard.

Warning!

Before starting removal procedure be sure to:

- Turn off electric power to the unit.
- Ensure spa water valves are closed (or that the spa is drained).

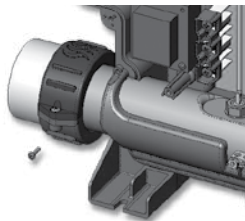

Loosen and remove the 2 screws and disengage the heater bracket. Remove the heater and replace with a new one. Put the heater bracket back in place and secure it with the 2 screws.

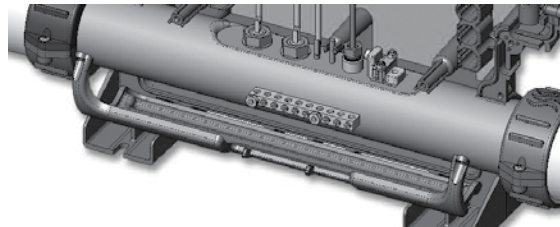

Adjust the heater position and tighten the screws. Plug the in.flo connector back in socket P42. Plug the HL probe and temp probe connectors back in socket P38.

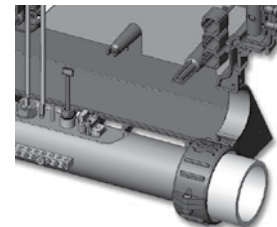

Reconnect the heater connections: Return, Live and Ground. Tighten the screws with a Phillips screwdriver. Put the cover back in place and tighten the 4 or 6 screws with a Phillips screwdriver. Screw fittings to the spa pipe system, making sure that the piping and nut threads are not over tightened.

Reopen the spa water valves or fill the spa and check for leaks.



How to replace main control board on in.ye

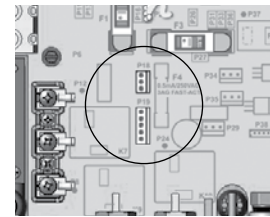
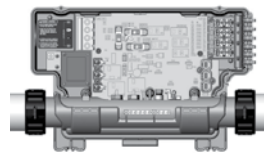
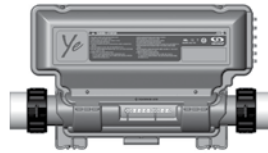

⚠ Warning!

Before starting removal procedure be sure to:

- Turn off electric power to the unit.

Using a Phillips screwdriver, loosen the 4 screws that hold the cover in place. Disconnect incoming power lines by loosening the screws on the terminals of the terminal block.

Use a Phillips screwdriver to loosen the terminals and remove all electrical heater connections: Return, Live and Ground. Manually remove the HL probe & Temp. probe connector. Manually remove in.flo connector. Be careful not to damage any connector by twisting or pulling too hard.

Manually remove the transformer connector. Manually remove the topside cable and the in.link cables

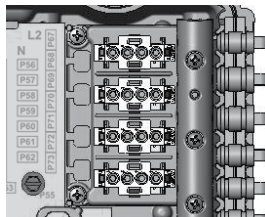

Use a Phillips screwdriver to loosen and remove the cable strain relief cover. Unplug power cord by squeezing the latches on the side of each AMP plug and pulling it from its socket, one at a time, identify each output power cord.

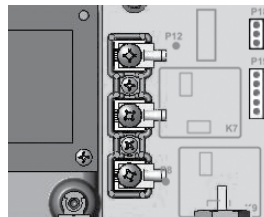

Using the Phillips screwdriver remove the strain relief bracket. Remove the 2 screws from the assembly AMP bracket. Remove the 2 screws of the shroud around the heater's connection post and remove it.

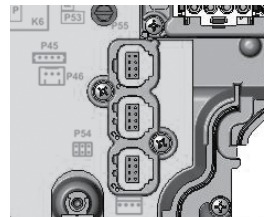

Do the same for the in.link bracket.

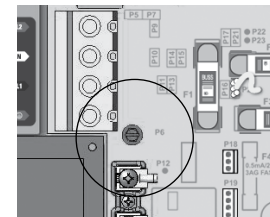

Unscrew the 2 green grounding screws located on either side of the PCB. Slide the PCB down to disengage it from the upper holder. Pull it and slide it upward to remove the card from the in.ye enclosure. Unplug the wires coming from the AMP bracket from the faulty board and replug them in the same location on the new board.

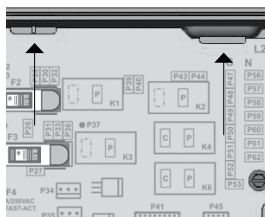

Be sure the ground connection bracket holds in place on the 2 locating pins in the enclosure. Put the new PCB back in the enclosure. Slide it downward, at an incline, behind the heater assembly. Then push it back, just underneath the

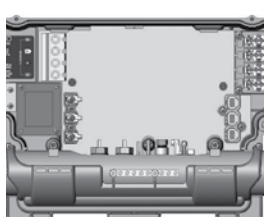

upper PCB holder, and slide it upward. Install the 2 green ground screws. Be sure the circuit board is lying flat on the back of the enclosure. Put the in.link bracket back in place and secure it with the 2 screws. Be sure the locating pin is fully in the PCB hole.

Install the shroud around the heater's connection posts. Reinstall the AMP assembly bracket. Put the strain relief bracket in place. Plug the topside and in.link cables back in. Plug the output power cord in its initial location. Screw the strain relief cover in place. Reinstall the transformer connector. Plug the in.flo, the HL probe and temperature probe connectors back in. Plug the heater connections back in: Return, Live, and Ground.

Tighten the screws with a Phillips screwdriver. Connect the incoming power lines and tighten the terminal block screws firmly. Put the cover back in place and tighten the 4 screws.



How to replace the main control board on in.yt

⚠ Warning!

Before starting removal procedure be sure to:

- Turn off electric power to the unit.

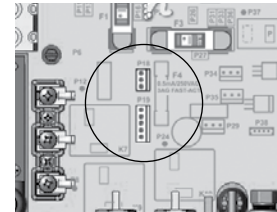
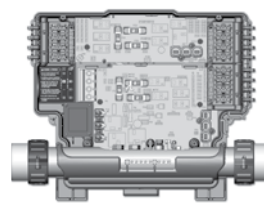
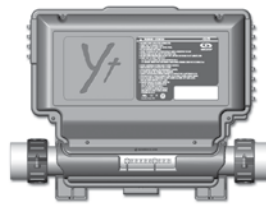

Using a Phillips screwdriver, loosen the 6 screws that hold the cover in place. Disconnect incoming power lines by loosening the screws on the terminals of the terminal block.

Use a Phillips screwdriver to loosen the terminals and remove all electrical heater connections: Return, Live and Ground. Manually remove the HL probe & Temp. probe connector. Manually remove in.flo connector. Be careful not to damage any connector by twisting or pulling too hard.

Manually remove the transformer connector. Manually remove the topside cable and the in.link cables.

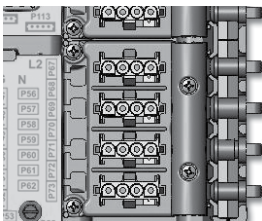

Use a Phillips screwdriver to loosen and remove the cable strain relief cover. Unplug power cord by squeezing the latches on the side of each AMP plug and pulling it from its socket, one at a time, identify each output power cord.

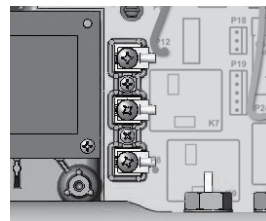

Using the Phillips screwdriver remove the strain relief bracket. Remove the 2 screws from the assembly AMP bracket. Remove the 2 screws of the shroud around the heater's connection post and remove it.

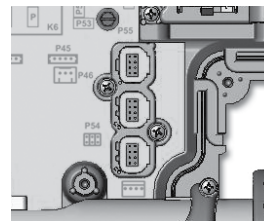

Do the same for the in.link bracket.

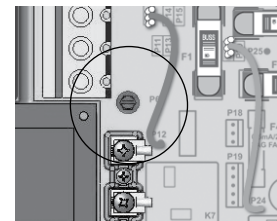

Unscrew the 2 green grounding screws located on either side of the PCB. Slide the PCB down to disengage it from the middle holder. Pull it and slide it upward to remove the card from the in.yt enclosure.

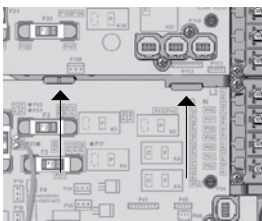

Put the new PCB back in the enclosure. Slide it downward, at an incline, behind the heater assembly. Then push it back, just underneath the middle PCB holder, and slide it upward. Install the 2 green ground screws. Be sure the circuit board is

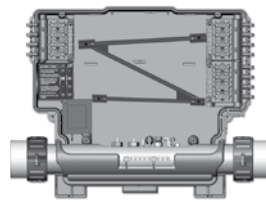

lying flat on the back of the enclosure. Put the in.link bracket back in place and secure it with the 2 screws. Be sure the locating pin is fully in the PCB hole. Install the shroud around the heater's connection posts. Reinstall the AMP assembly bracket. Put

the strain relief bracket in place. Plug the topside and in.link cables back in. Plug the output power cord in its initial location. Screw the strain relief cover in place. Reinstall the transformer connector. Plug the in.flo, the HL probe and temperature probe connectors back in. Plug the heater connections back in: Return, Live, and Ground. Tighten the screws with a Phillips screwdriver. Connect the incoming power lines and tighten

the terminal block screws firmly. Put the cover back in place and tighten the 6 screws.



How to replace the upper extension board on the in.yt

Warning!

Before starting removal procedure be sure to:

- Turn off electric power to the unit.

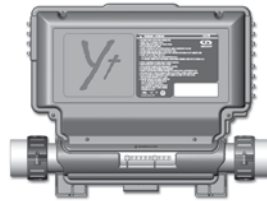

Using a Phillips screwdriver, loosen the 6 screws that hold the cover in place.

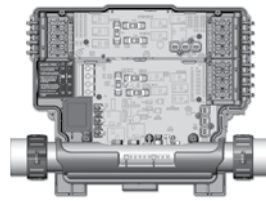

Identify each wire coming from the main board and remove them from the extension board.

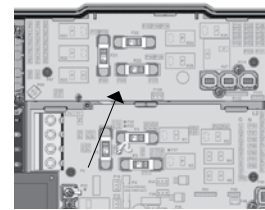

Remove the control cable from the upper board. Disconnect the incoming conductors from the screw lug terminal.

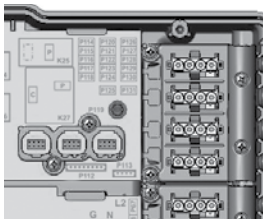

Remove the in.link cables. Identify and remove all the output power cord from the AMP assembly brackets left and right. Remove the strain relief covers, left and right, and remove cords. Do the same for the strain relief brackets. Remove screws from the AMP assembly brackets. Remove the 2 green grounding screws. Remove the in.link bracket.

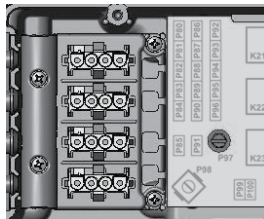

Remove the screw from the bottom left side of the PCB. Slide the circuit board downwards to disengage it from the upper PCB holder tab. Put the new circuit board in place by engaging it into the PCB holder tab. Secure the board with the bottom lefthand side screw. Put the 2 green grounding screws back in place. Reinstall the in.link bracket with its 2 screws.

Reinstall the 2 AMP assembly brackets and the strain relief brackets. Put all of the output power cords back in place and

secure them by reinstalling the strain relief covers. Plug the in.link cables and control cables from the main board back in. Reinstall all the remaining conductors coming from the main control board. Reconnect the incoming conductor to the screw lug terminal. Reinstall the cover and secure it with the 6 screws.



Specifications

Environmental ratings:

Operating temperature:	32°F (0°C) to 122°F (50°C)
Storage temperature:	-13°F (-25°C) to 185°F (85°C)
Humidity:	Up to 85% RH, non condensing
IPx5 level of waterproofing	

Mechanical:

in.ye

Weight:	Up to 9.7 lbs (4.4 kg)
Dimensions (W x H x D):	19.598" x 10.75" x 4.98" (497 x 273 x 126 mm)

in.yt

Weight:	Up to 12 lbs (4.45 kg)
Dimensions (W x H x D):	19.58" x 14.5" x 5.1" (497 x 368 x 130 mm)

Model Y Series UL/CSA electrical specifications

Input rating:	120/240 V AC nominal (+5/-10%) (2 lines required with neutral) 48 A Max,
or (in.ye-3 only):	120 V AC nominal only (+5/-10%) (single line with neutral) 16 A Max,
	60 Hz nominal (+1.5 / -1.0 Hz)

Heat.wav rating:

Voltage:	120 or 240 V, 60Hz
Wattage:	4 kW at 240 V, 1 kW at 120 V (Also available: 5.5 kW at 240 V AC)
Flow rate:	Minimum of 18 GPM is required

UL 1563 Sixth Ed.

UL File: E182156

CSA No. 22.2 - 218.1-M89.



Model Y Series TUV electrical specifications

Input rating:	230/240 V AC nominal (+5/-10%) (2-phase system with neutral) 20 A Max per phase, (3-phase system with neutral) 16A Max per phase.
or (in.ye-3 only):	240 V AC nominal only (+5/-10%) (single-phase system with neutral) 48 A Max, 50 Hz nominal (+1.5 / -1.0 Hz)

Heat.wav rating:

Voltage:	240 V AC, 50Hz
Wattage:	3.8 kW at 230 V AC
Flow rate:	Minimum of 18 GPM is required

EN/IEC 60335 - 2 - 60/A2: 2008 - EN/IEC 60335 - 1: 2010

EN55014-1

EN55014-2

EN61000-3-2

EN61000-3-3





Device	Voltage * ¹	Maximum current	ye-3* ²	ye-5	yt-7* ⁸	yt-12* ⁹
Pump 1 (2-spnd)	120 or 240 V	15 FLA/60 LRA (inrush)	●	●	●	●
Pump 2 (2-spnd)	120 or 240 V	15 FLA/60 LRA (inrush)	●* ³	●* ⁵	●	●
Pump 3 (2-spnd)	120 or 240 V	15 FLA/60 LRA (inrush)		●* ⁶	●	●
Pump 4 (2-spnd)	120 or 240 V	15 FLA/60 LRA (inrush)				●
Pump 5 (1-spnd)	120 or 240 V	15 FLA/60 LRA (inrush)				●
O3/CP	120 or 240 V	6 FLA/10 A	●* ⁴	●		●
A1	120 or 240 V	15 FLA/60 LRA (inrush)				●
Blower	120 or 240 V	15 FLA/60 LRA (inrush)				●
CP	120 or 240 V	6 FLA/10 A			●	●
O3	120 or 240 V	6 FLA/10 A			●	●
Direct out 1	120 or 240 V	10 A (always on)		●* ⁷	●	●
Direct out 2	120 or 240 V	10 A (always on)			●	●

*¹ The output voltage for the TUV version will reflect the input voltage typically 230 V AC

*² This model can be converted to a dedicated 120 V model.

*³ Pump #2 can only be installed if Pump #1 is a single-speed pump.

*⁴ Total of Pump #1-low (or Pumps #2) and O3/ CP cannot exceed 15 FLA.

*⁵ Total of Pump #2 and Pump #3 cannot exceed 22 FLA.

*⁶ Pump #3 can only be installed if Pump #2 is a single-speed pump.

*⁷ Total of Pump #1-low, O3/ CP, and Direct #1 cannot exceed 15 FLA.

*⁸ If CP is used, Pump 3 must be 1-speed
 Total of pump 1-low, O3 and Di1 must not exceed 15 FLA
 Total of P3, CP, and Di2 must not exceed 15 FLA

*⁹ If A1 is used, Pump 4 must be 1-speed
 Total of O3 and Di1 must not exceed 15 FLA
 Total of P3, CP, and Di2 must not exceed 15 FLA
 Total of P5, and B must not exceed 17 FLA
 Total of P4, and A1 must not exceed 22 FLA

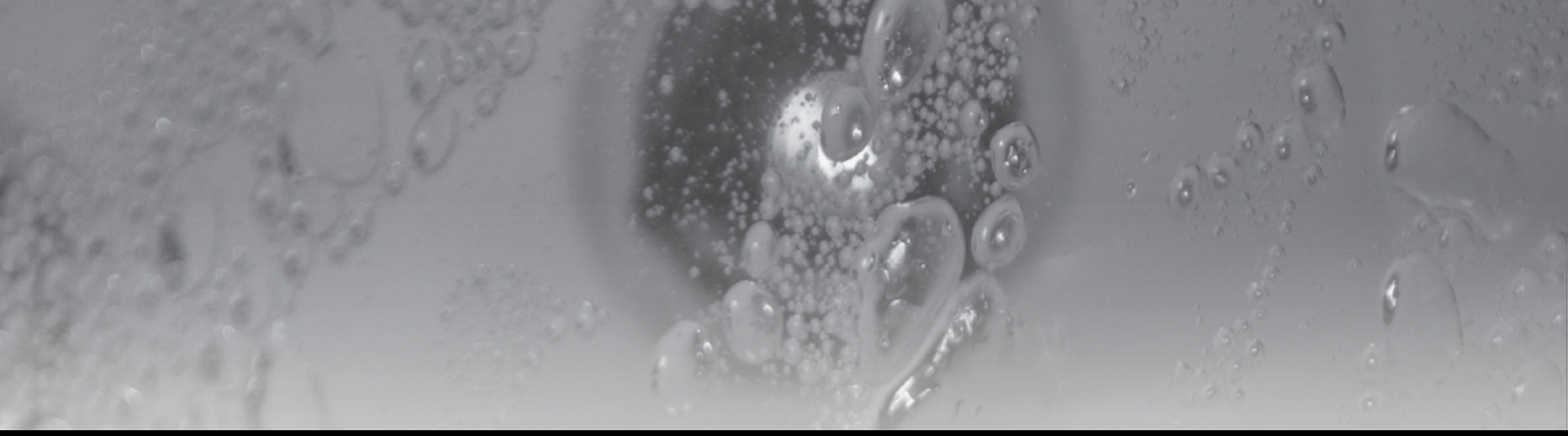

Gecko Alliance

450 des Canetons, Quebec City (Qc), G2E 5W6 Canada, 1.800.78.GECKO
9225 Stellar Court, Corona, CA 92883 USA, 951.667.2000

www.geckoalliance.com

9919-101184
Rev. 08-2012

© Groupe Gecko Alliance Inc., 2012
All trademarks or registered trademarks
are the property of their respective owners.



Printed in Canada 08-2012