

welldana®



Summary

For users P.3-P.9

1. General information:.....	- 3 -
1.1. Contents:	- 3 -
1.2. Operating conditions and range:	- 3 -
1.3. Advantages of different modes:.....	- 3 -
1.4. Kind reminder:.....	- 4 -
2. Operations	- 6 -
2.1. Notice before using	- 6 -
2.2. Operation instructions	- 6 -
2.3. Daily maintenance and winterizing	- 6 -
3. Technical specification	- 9 -

For installers and professionals P.10-P.27

1. Transportation.....	- 10 -
2. Installation and maintenance.....	- 10 -
2.1. Notice before installation:	- 10 -
2.2. Installation instruction.....	- 11 -
2.3. Trial after installation	- 14 -
2.4. Maintenance and winterizing.....	- 14 -
3. Trouble shooting for common faults	- 15 -
4. Failure code	- 16 -
<i>Appendix 1: Heating priority wiring diagram (Optional).....</i>	<i>- 17 -</i>
<i>Appendix 2: Heating priority wiring diagram (Optional).....</i>	<i>- 18 -</i>
<i>Appendix 3: Heating priority wiring diagram (Optional).....</i>	<i>- 19 -</i>
6. Wifi setting	Fejl! Bogmærke er ikke defineret.



Warning:

- Please read the following tips before installation, use and maintenance.
- Installation, removal and maintenance must be carried out by Professional personial in accordance with the instructions.
- Gas leakage test must be done before and after installation.

1. Use

- It must be installed or removed by professionals, and it is forbidden to dismantle and refit without permission.
- Don't put obstacles before the air inlet and outlet of the heat pump.**

2. Installation

- This product must be kept away from any source of fire.

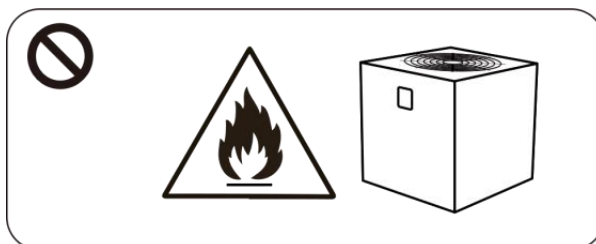

- The installation can't be in a closed environment or indoors, and must be kept well ventilated.

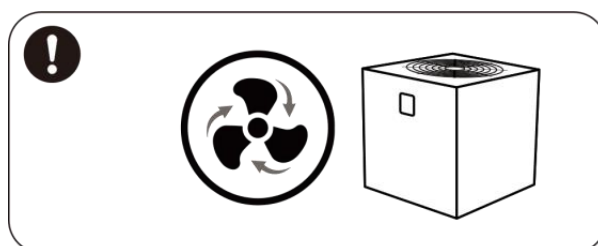

- c. Vacuum completely before welding, field welding is not allowed, welding can only be performed by professional personnel in professional maintenance center.

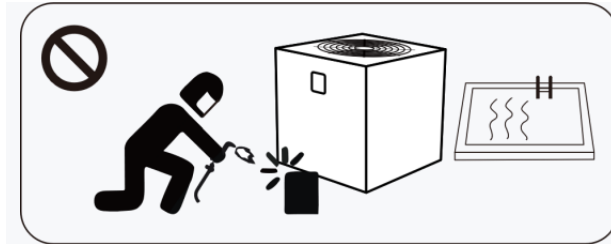

- d. Installation must be stopped if any gas leakage, and the unit must be returned to professional maintenance center.

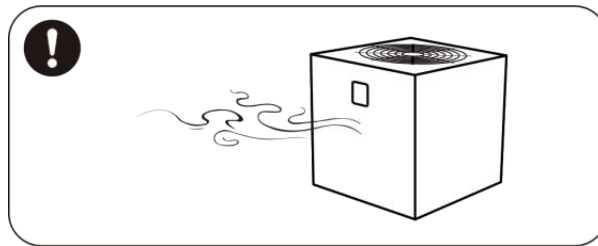

3. Transportation & Storage

- Sealing is not allowed during transportation
- Transporting goods at a constant speed is needed to avoid sudden acceleration or sudden braking, so as to reduce the collision of goods.
- The unit must be far away from any source of fire.
- Storage place must be bright, wide, open and good ventilation, ventilation equipment is required.

4. Maintenance Notice

- If maintenance or scrap is required, contact an authorized service center nearby
- Qualification requirement
All operators who dispose gas must be qualified by valid certification which issued by professional agency.
- Please strictly comply with the requirement from manufacturer when maintenance or filling gas. please refer to the technical service manual.

> 1. General information:

1.1. Contents:

After unpacking, please check if you have all the following components.

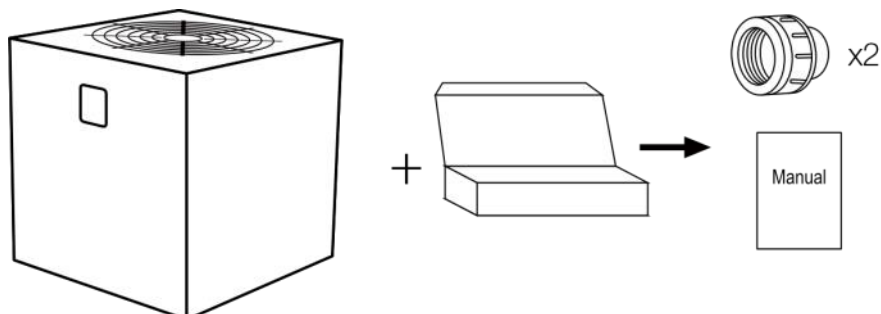



1.2. Operating conditions and range:

ITEMS		RANGE
Operating range	Air temp	-15°C~43°C
Temp. setting	heating	18°C~40°C

The heat pump will have ideal performance in the operation range Air 15°C~25°C

1.3. Advantages of different modes:

The heat pump has two modes: Turbo, Smart and Silence. They have different advantages under different conditions

MODE	ADVANTAGES
Turbo mode 	Heating capacity: 120% Fast heating
Smart mode 	Heating capacity: 100%~20% Intelligent optimization according to ambient temperature and water temperature Energy efficiently saving
Silence mode 	Heating capacity: 60%~20% Use at night

1.4. Kind reminder:

⚠This heat pump has Power-off memory function. When the power is recovered, the heat pump will restart automatically.

1.4.1. The heat pump can only be used to heat the pool water. It can NEVER be used to heat other flammable or turbid liquid.

1.4.2. Don't lift the water union when moving the heat pump since the titanium heat exchanger inside the heat pump will be damaged.

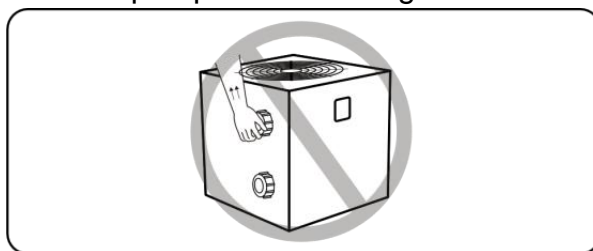

1.4.3. Don't put obstacles before the air inlet and outlet of the heat pump.

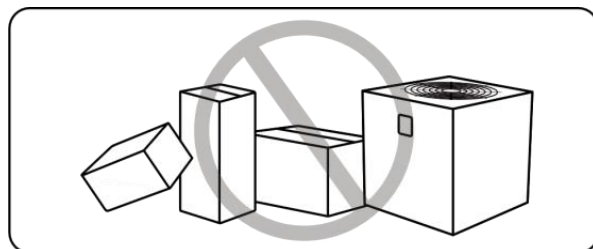

1.4.4. Don't put anything into inlet or outlet, or the efficiency of the heat pump will be reduced or even stopped.

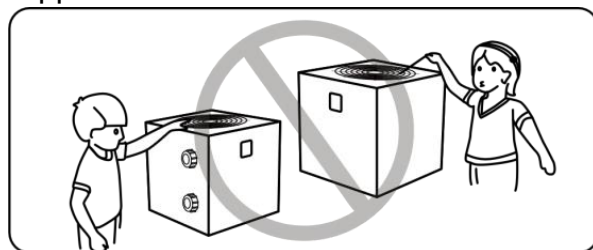

1.4.5. Don't use or store combustible gas or liquid such as thinners, paint and fuel to avoid fire.

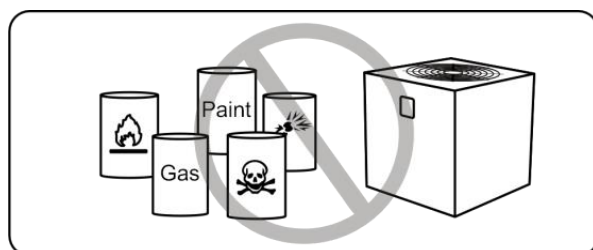

1.4.6. If any abnormal circumstances occurred, e.g.: abnormal noises, smells, smokes and leakage of electricity, switch off the main power immediately and contact your local dealer. Don't try to repair the heat pump by yourselves.

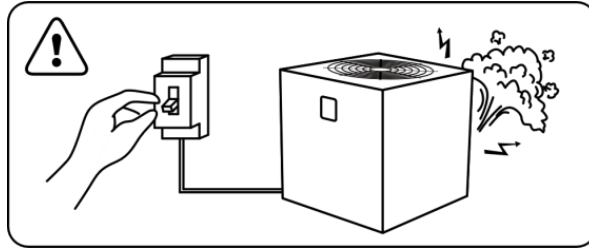

1.4.7. The main power switch should be out of the reach of Children.

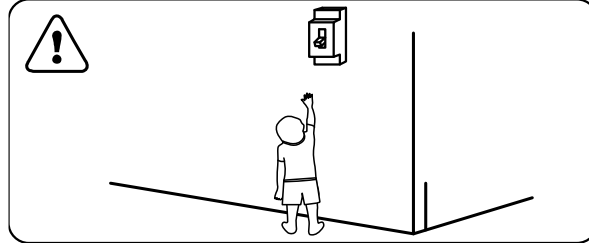

1.4.8. Please cut off the power in the lightning storm weather.

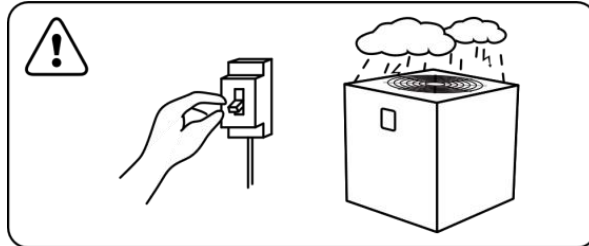

1.4.9. Please note that following codes are not failure.

	Codes
No water flow	E3
Anti-Freezing Reminder	Ed
Out of the operating range	Eb
Insufficient water flow or pump blocked	E6
Power abnormal	E5





> 2. Operations

2.1. Notice before using

- ① For longer service life, please ensure water pump is on before heat pump is on, and water pump is off after heat pump is off.
- ② Ensure no water leakage on piping system, then unlock screen and press  to power on heat pump.

2.2. Operation instructions



SYMBOL	DESIGNATION	FUNCTION
	ON/OFF	Power On/Off
	Unlock	Press it for 3 seconds to unlock/lock screen
	Speed	Select Smart/Silence/Turbo mode
	Up / Down	Adjust set temperature

Note:

- ① Screen lock:
 - a. If no operation in 30 seconds, screen will be locked.
 - b. When HP is off, screen will be dark and "0%" will be displayed.





c. Press  for 3 seconds to lock screen and it will be dark

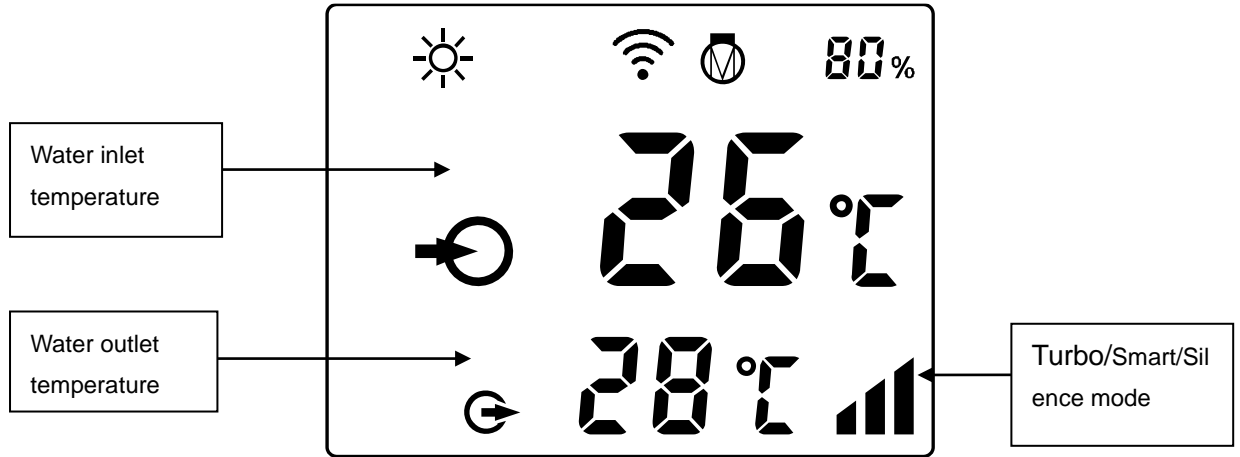

② Screen unlock:



a. Press  for 3 seconds to unlock screen and it will be lit up.

b. Only after screen is unlocked, any other buttons can be functioned.





	Heating
	Heating capacity percentage
	Wifi connection
	Water inlet
	Water outlet

1.Power On: Press  for 3 seconds to light up screen, then press  to power on heat pump.

2.Adjust Set Temperature: When screen is unlocked, press  or  to display or adjust the set temperature.

3.Turbo/Smart/Silence mode selection:

① Smart mode as default will be activated when heat pump is on, and screen shows .

② Press  to enter Turbo mode, and screen shows , then press  to enter Silence mode, the screen shows . Press  again, the screen shows  and return to Smart mode.

Attention:

a. When use the Turbo mode, you should select it every time, the machine will not automatically enter the

Turbo mode.

b. During the Turbo mode, when the machine reaches the set temperature, it will automatically return to the smart mode.

4. Defrosting

a. Auto Defrosting: When heat pump is defrosting, ☀ will be flashing. After defrosting, ☀ will stop flashing.

b. Compulsory Defrosting: When heat pump is heating, press 🌀 and — together for 5 seconds to start compulsory defrosting, and ☀ will be flashing. After defrosting, ☀ will stop flashing.

(Note: Compulsory defrosting intervals should be more than 30 minutes and the compressor should run for more than 10 minutes.)

5. Temperature display conversion between °C and °F:

Press "+ " and "—" together for 5 seconds to switch between °C and °F.

6. Wifi setting

Please kindly check the last page.

2.3. Daily maintenance and winterizing

2.3.1. Daily Maintenance

⚠ Please don't forget to cut off power supply of the heat pump

- Please clean the evaporator with household detergents or clean water, NEVER use gasoline, thinners or any similar fuel.
- Check bolts, cables and connections regularly.

2.3.2. Winterizing

In winter season when you don't swim, please cut off power supply and drain water out of the heat pump. When using the heat pump under 2°C, make sure there is always water flow.

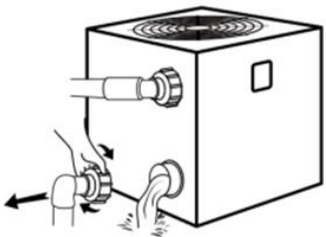

⚠ Important:
 Unscrew the water union of inlet pipe to let the water flow out.
 When the water in machine freezes in winter season, the titanium heat exchanger may be damaged.

> 3. Technical specification

Model	AXR10V	AXR13V	AXR17V	AXR21V	AXR26V	AXR32V	AXR32VT	AXR40VT
Advised pool volume (m ³)	20~40	25~50	30~60	40~75	50~100	65~120	65~120	90~160
Working air temp (°C)	-15~43							
Performance Condition: Air 26°C, Water 26°C, Humidity 80%								
Heating capacity (kW) in Smart mode	8.5	11.0	14.0	17.5	22.0	27.0	27.0	35.0
Heating capacity (kW) in Turbo mode	10.2	13.2	17.2	21.0	26.0	31.5	31.5	40.0
C.O.P in Smart mode	7.6	7.7	7.8	7.3	7.8	7.4	7.4	7.3
C.O.P	14.9~6.6	15.0~6.8	15.6~6.5	15.5~6.3	14.9~6.8	16.0~6.3	16.0~6.3	15.7~6.4
C.O.P at 50% speed	11.2	11.5	11.7	11.6	11.3	11.2	11.2	11.1
Performance Condition: Air 15°C, Water 26°C, Humidity 70%								
Heating capacity (kW) in Smart mode	6.3	7.3	9.8	11.6	14.5	18.0	18.0	24.5
Heating capacity (kW) in Turbo mode	7.5	8.8	11.6	14.3	17.5	21.5	21.5	28.5
C.O.P in Smart mode	5.0	5.0	4.9	4.9	5.0	5.3	5.3	5.1
C.O.P	7.0~4.3	7.3~4.5	7.8~4.5	7.4~4.4	7.3~4.8	7.8~4.9	7.8~4.9	7.7~4.8
C.O.P at 50% speed	6.4	6.5	6.7	6.8	6.3	6.8	6.8	6.7
Sound pressure at 1m dB(A)	38.8~46.5	38.8~47.9	42.2~48.6	43.1~52.1	41.0~52.9	43.6~53.8	43.6~53.8	42.8~54.0
Sound pressure of 50% capacity at 1m dB(A)	39.0	41.9	44.3	45.2	45.3	46.7	46.7	46.9
Sound pressure at 10m dB(A)	18.8~26.5	18.8~27.9	22.2~28.6	23.1~32.1	21.0~32.9	23.6~33.8	23.6~33.8	22.8~34.0
Power supply	230V/1 Ph/50Hz						400V/3 Ph/50Hz	
Rated input power(kW) at air 15°C	0.17~1.66	0.21~1.95	0.26~2.51	0.33~3.08	0.42~3.67	0.46~4.4	0.46~4.4	0.60~5.94
Rated input current(A) at air 15°C	0.74~7.21	0.91~8.48	1.14~10.9	1.43~13.4	1.82~15.9	2.01~19.1	0.66~6.35	0.87~8.57
Advised water flux (m ³ /h)	2~4	3~4	4~6	6.5~8.5	8~10	10~12	10~12	12~18
Water pipe in-out Spec (mm)	50							
Net Dimension Lx WxH (mm)	710x753 x668	710x753 x668	710x775 x668	710x775 x668	710x775 x743	729x955 x917	729x955 x917	845x955 x917
Net Weight (kg)	61	66	71	78	102	110	117	141

- The values indicated are valid under ideal conditions: Pool covered with an isothermal cover, filtration system running at least 15 hours a day.
- Related parameters are subject to adjustment periodically for technical improvement without further notice. For details please refer to nameplate.

> 1. Transportation

1.1. When storing or moving the heat pump, the heat pump should be at the upright position.

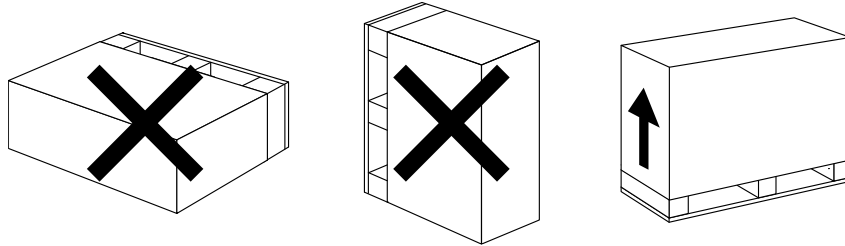

1.2. When moving the heat pump, do not lift the water union since the titanium heat exchanger inside the heat pump will be damaged.

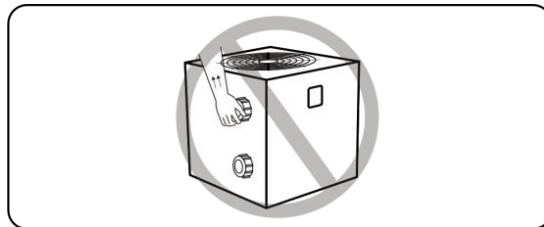

> 2. Installation and maintenance

! The heat pump must be installed by a professional team. The users are not qualified to install by themselves, otherwise the heat pump might be damaged and risky for users' safety.

2.1. Notice before installation:

2.1.1. The inlet and outlet water unions can't bear the weight of soft pipes. The heat pump must be connected with hard pipes!

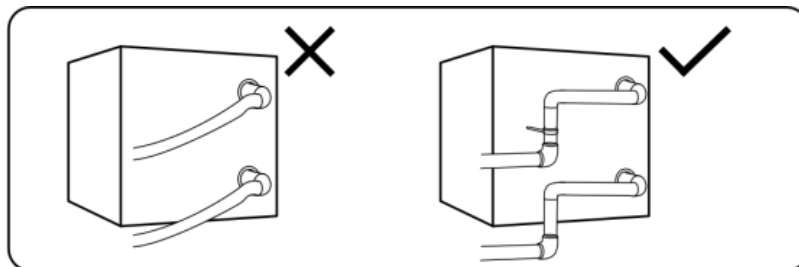

2.1.2. In order to guarantee the heating efficiency, the water pipe length should be $\leq 10\text{m}$ between the pool and the heat pump.

2.2. Installation instruction

2.2.1. Location and size

⚠ To avoid air recirculation, the heat pump should be installed in a place with good ventilation or should reserve sufficient space for installation and maintenance. Please refer to the schema below:

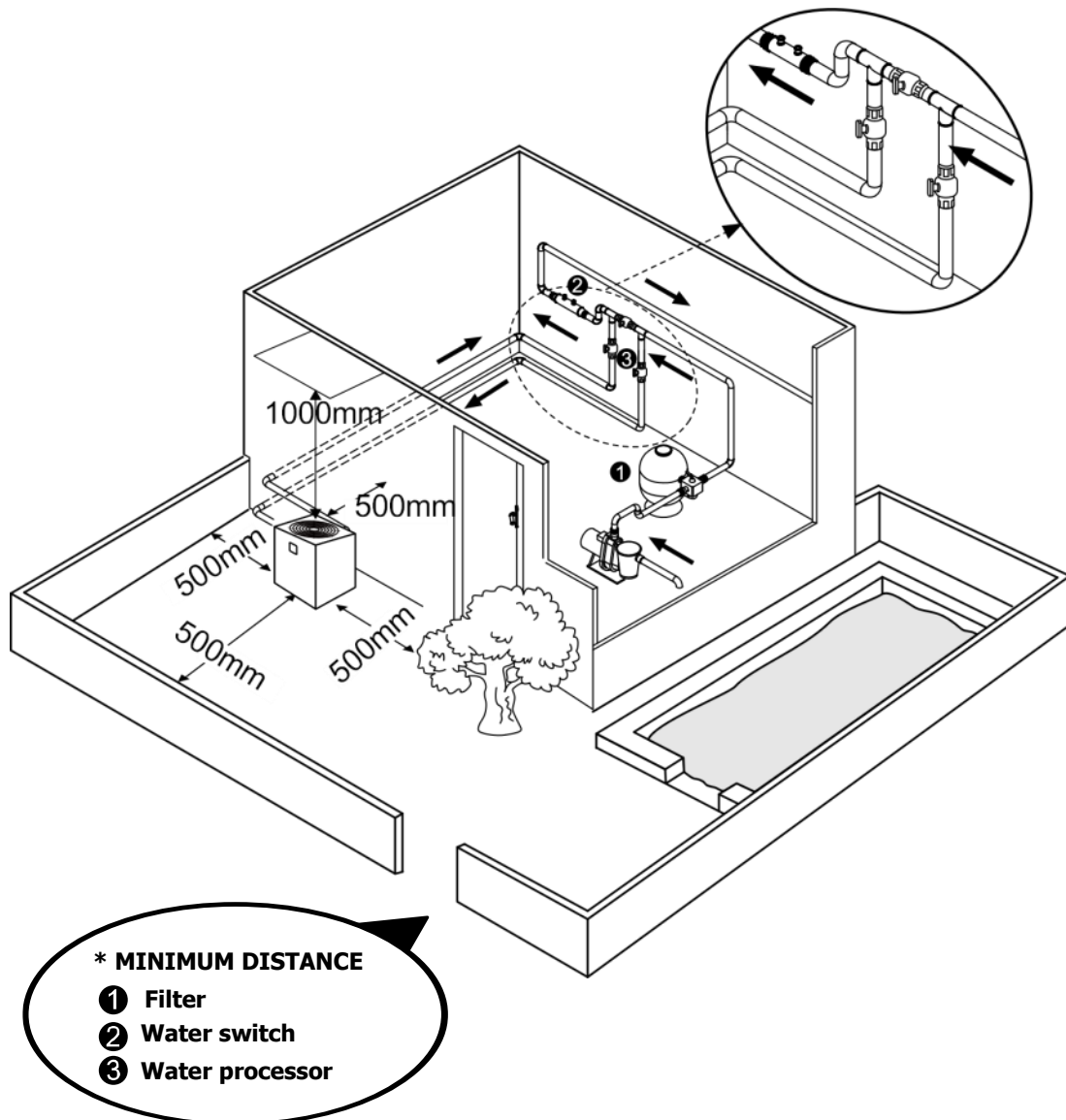

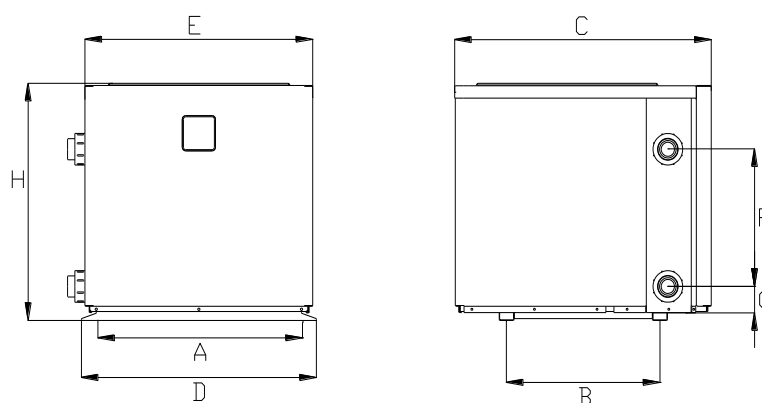

UNIT=MM		A	B	C	D	E	F	G	H
Model	AXR10V	685	441	753	710	688	300	75.5	668
	AXR13V	685	441	753	710	688	280	75.5	668
	AXR17V	685	463	775	710	688	350	75.5	668
	AXR21V	685	463	775	710	688	390	75.5	668
	AXR26V	685	463	775	710	688	460	75.5	743
	AXR32V	703	555	955	729	707	640	75.5	917
	AXR32VT	703	555	955	729	707	640	75.5	917
	AXR40VT	819	555	955	845	823	650	75.5	917

※ Above data is subject to modification without notice.

2.2.2. Heat pump installation.

- The frame must be fixed by bolts (M10) to concrete foundation or brackets. The concrete foundation must be solid; the bracket must be strong enough and anti-rust treated;
- The heat pump needs a water pump (Supplied by the user). The recommended pump specification-flux: refer to Technical Parameter, Max. lift $\geq 10\text{m}$
- When the heat pump is running, there will be condensation water discharged from the bottom, please pay attention to it.

2.2.3. Wiring & protecting devices and cable specification

- Connect to appropriate power supply, the voltage should comply with the rated voltage of the products.
- Well earth the heat pump.
- Wiring must be connected by a professional technician according to the circuit diagram.
- Set breaker or fuse according to the local code (leakage operating current $\leq 30\text{mA}$).
- The layout of power cable and signal cable should be orderly and not affecting each other.

⚠ 1. Wiring diagram

A. For power supply: 230V 50Hz

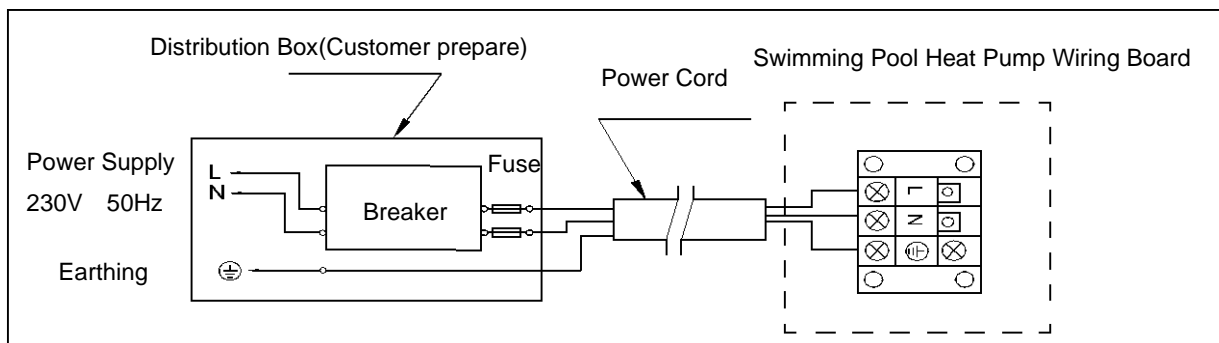

B. For power supply: 400V 50Hz

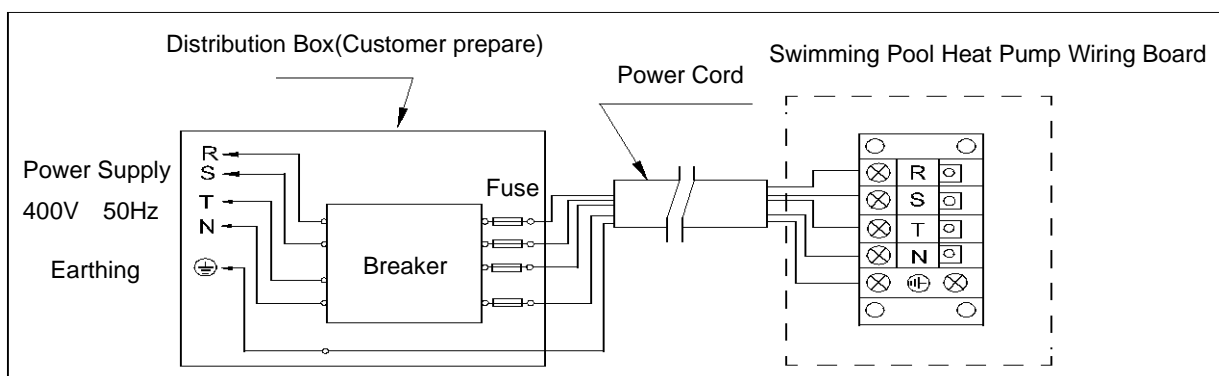

Note:

⚠ Must be hard wired, no plug allowed.

- For your safe use in winter, it's strongly recommended to equip heating priority function.
- For the detailed wiring diagram, please refer to Appendix 1.

2. Options for protecting devices and cable specification

MODEL		AXR10V	AXR13V	AXR17V	AXR21V	AXR26V	AXR32V	AXR32VT	AXR40VT
Breaker	Rated Current A	12.0	15.0	19.0	22.5	25.5	28.5	11.3	15.0
	Rated Residual Action Current mA	30	30	30	30	30	30	30	30
	Fuse A	12.0	15.0	19.0	22.5	25.5	28.5	11.3	15.0
	Power Cord (mm ²)	3×2.5	3×2.5	3×4	3×4	3×6	3×6	5×2.5	5×2.5
	Signal cable (mm ²)	3×0.5	3×0.5	3×0.5	3×0.5	3×0.5	3×0.5	3×0.5	3×0.5

NOTE: The above data is adapted to power cord ≤ 10m. If power cord is > 10m, wire diameter must be increased. The signal cable can be extended to 50m at most.

2.3. Trial after installation

! Please check all the wirings carefully before turning on the heat pump.

2.3.1. Inspection before use

- Check installation of the whole heat pump and the pipe connections according to the pipe connecting drawing;
- Check the electric wiring according to the electrical wiring diagram and earthing connection;
- Make sure that the main power is well connected;
- Check if there is any obstacle in front of the air inlet and outlet of the heat pump

2.3.2. Trial

- The user is advised to start the water pump before the heat pump, and turn off the heat pump before the water pump for long life circle.
- The user should start the water pump, and check for any leakage of water; Power on and press the ON/OFF button of the heat pump, and set desired temperature in the thermostat.
- In order to protect the heat pump, the heat pump is equipped with start delay function. When starting the heat pump, the fan will start to run in 3 minutes, in another 30 seconds, the compressor will start to run.
- After pool heat pump starts up, check for any abnormal noise from the heat pump.
- Check the temperature setting

2.4. Maintenance and winterizing

2.4.1 Maintenance

! The maintenance should be carried out once per year by qualified professional technician.

- Cut off power supply of the heat pump before cleaning, examination and repairing . Do not touch the electronic components until the LED indication lights on PCB turn off.
- Please clean the evaporator with household detergents or clean water, NEVER use gasoline, thinners or any similar fuel.
- Check bolts, cables and connections regularly.

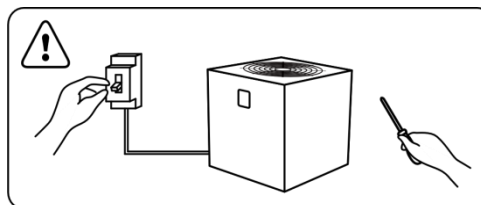

2.4.2 Winterizing

In winter season when you don't swim, please cut off power supply and drain water out of the heat pump. When using the heat pump under 2°C, make sure there is always water flow.

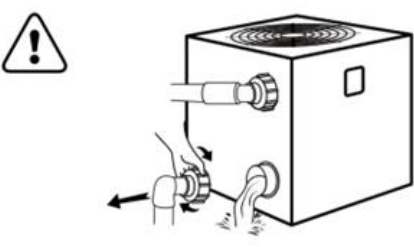

! Important:
 Unscrew the water union of inlet pipe to let the water flow out.
 When the water in machine freezes in winter season, the titanium heat exchanger may be damaged.

> 3. Trouble shooting for common faults

Failure	Reason	Solution
Heat pump doesn't run	No power	Wait until the power recovers
	Power switch is off	Switch on the power
	Fuse burned	Check and change the fuse
	The breaker is off	Check and turn on the breaker
Fan running but with insufficient heating	evaporator blocked	Remove the obstacles
	Air outlet blocked	Remove the obstacles
	3 minutes start delay	Wait patiently
Display normal, but no heating	Set temp. too low	Set proper heating temp.
	3 minutes start delay	Wait patiently
If above solutions don't work, please contact your installer with detailed information and your model number. Don't try to repair it yourself.		

ATTENTION! Please don't try to repair the heat pump by yourself to avoid any risk.

> 4. Failure code

NO.	Display	Not failure description
1	E3	No water protection
2	E5	Power supply excesses operation range
3	E6	Excessive temp difference between inlet and outlet water(Insufficient water flow protection)
4	Eb	Ambient temperature too high or too low protection
5	Ed	Anti-freezing reminder
NO.	Display	Failure description
1	E1	High pressure protection
2	E2	Low pressure protection
3	E4	3 phase sequence protection (three phase only)
4	E7	Water outlet temp too high or too low protection
5	E8	High exhaust temp protection
6	EA	Evaporator overheat protection (only at cooling mode)
7	P0	Controller communication failure
8	P1	Water inlet temp sensor failure
9	P2	Water outlet temp sensor failure
10	P3	Gas exhaust temp sensor failure
11	P4	Evaporator coil pipe temp sensor failure
12	P5	Gas return temp sensor failure
13	P6	Cooling coil pipe temp sensor failure
14	P7	Ambient temp sensor failure
15	P8	Cooling plate sensor failure
16	P9	Current sensor failure
17	PA	Restart memory failure
18	F1	Compressor drive module failure
19	F2	PFC module failure
20	F3	Compressor start failure
21	F4	Compressor running failure
22	F5	Inverter board over current protection
23	F6	Inverter board overheat protection
24	F7	Current protection
25	F8	Cooling plate overheat protection
26	F9	Fan motor failure
27	Fb	Power filter plate No-power protection
28	FA	PFC module over current protection

Appendix 1: Heating priority wiring diagram (Optional)

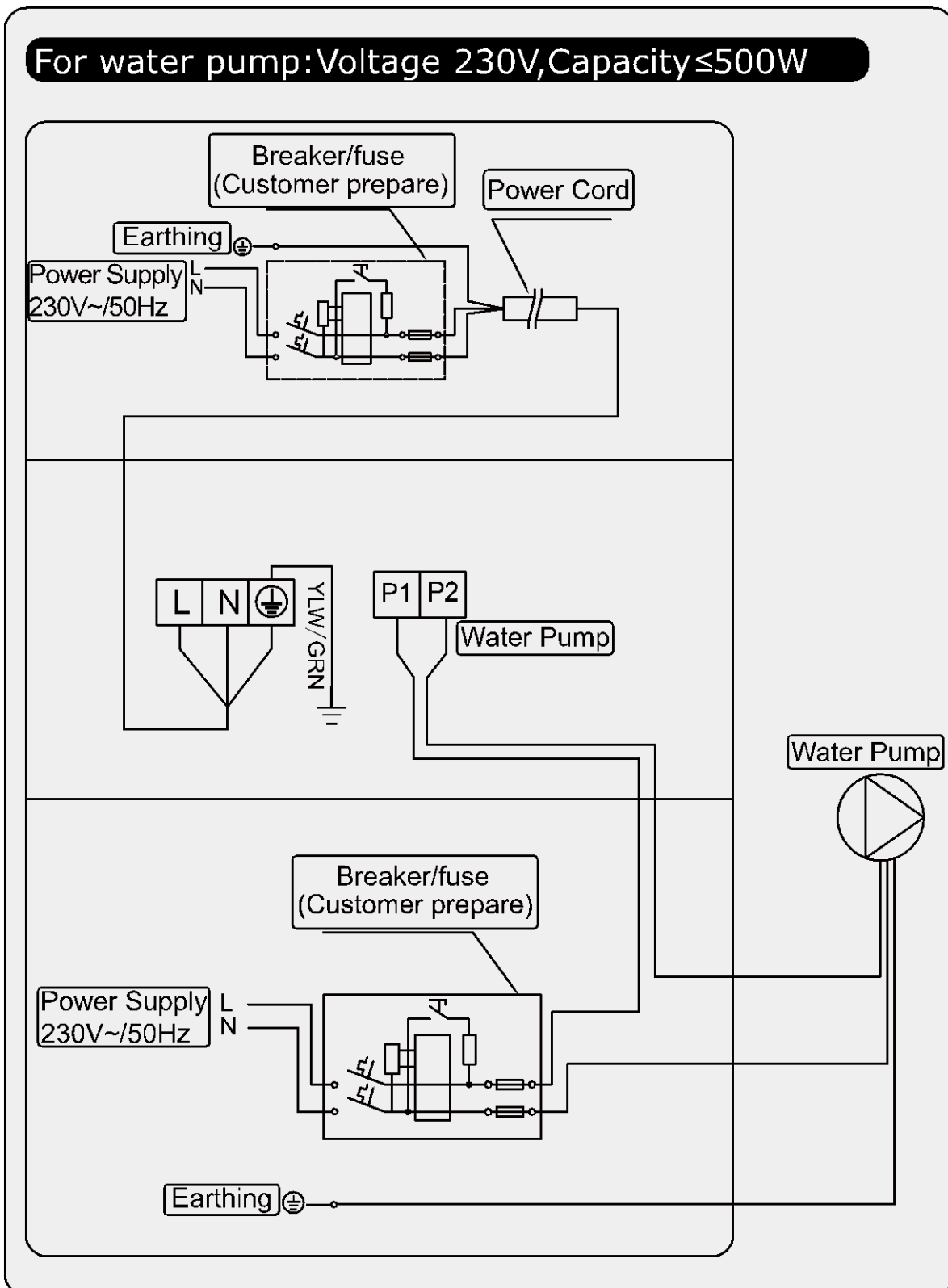

Appendix 2: Heating priority wiring diagram (Optional)

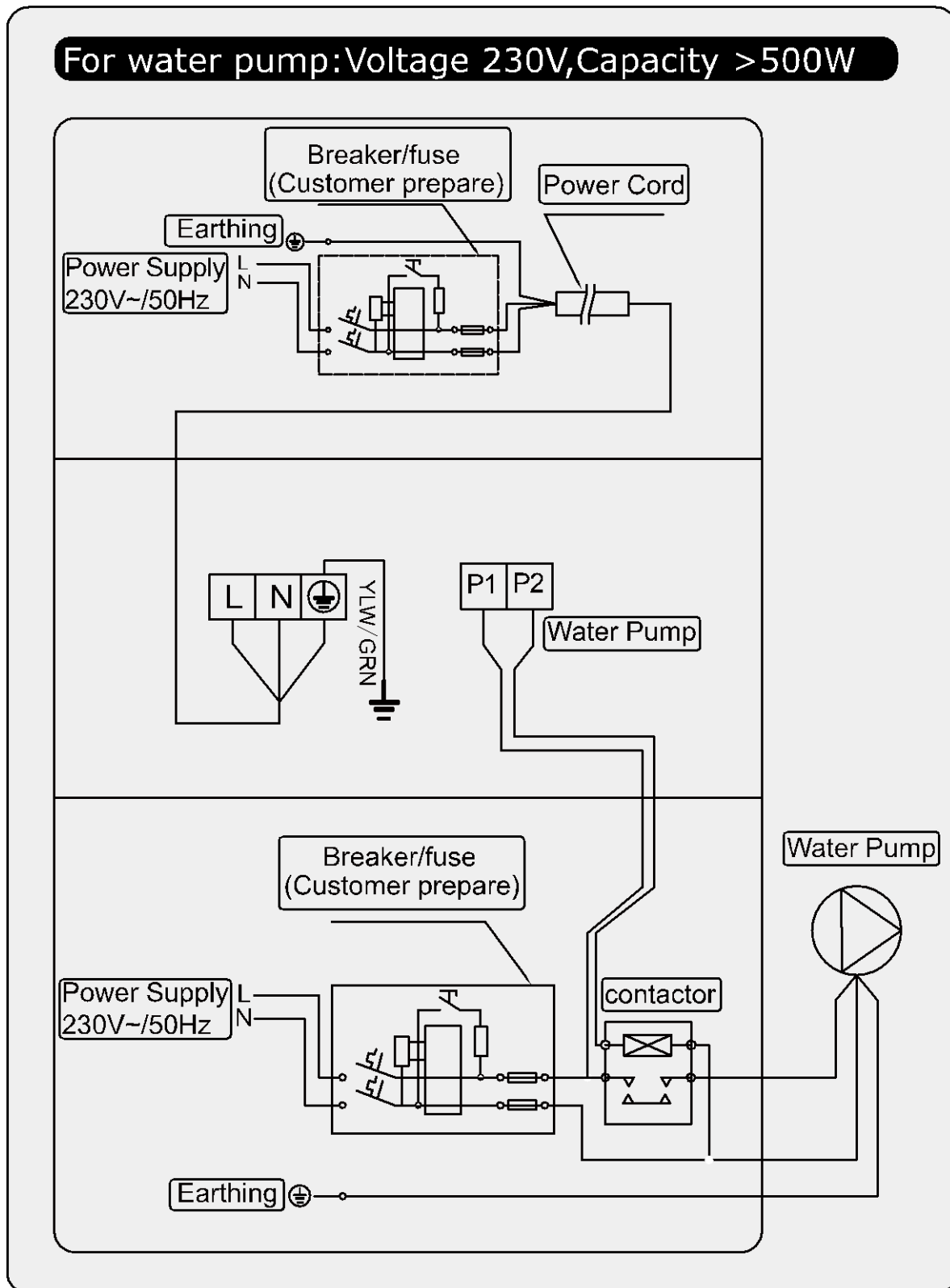

Appendix 3: Heating priority wiring diagram (Optional)

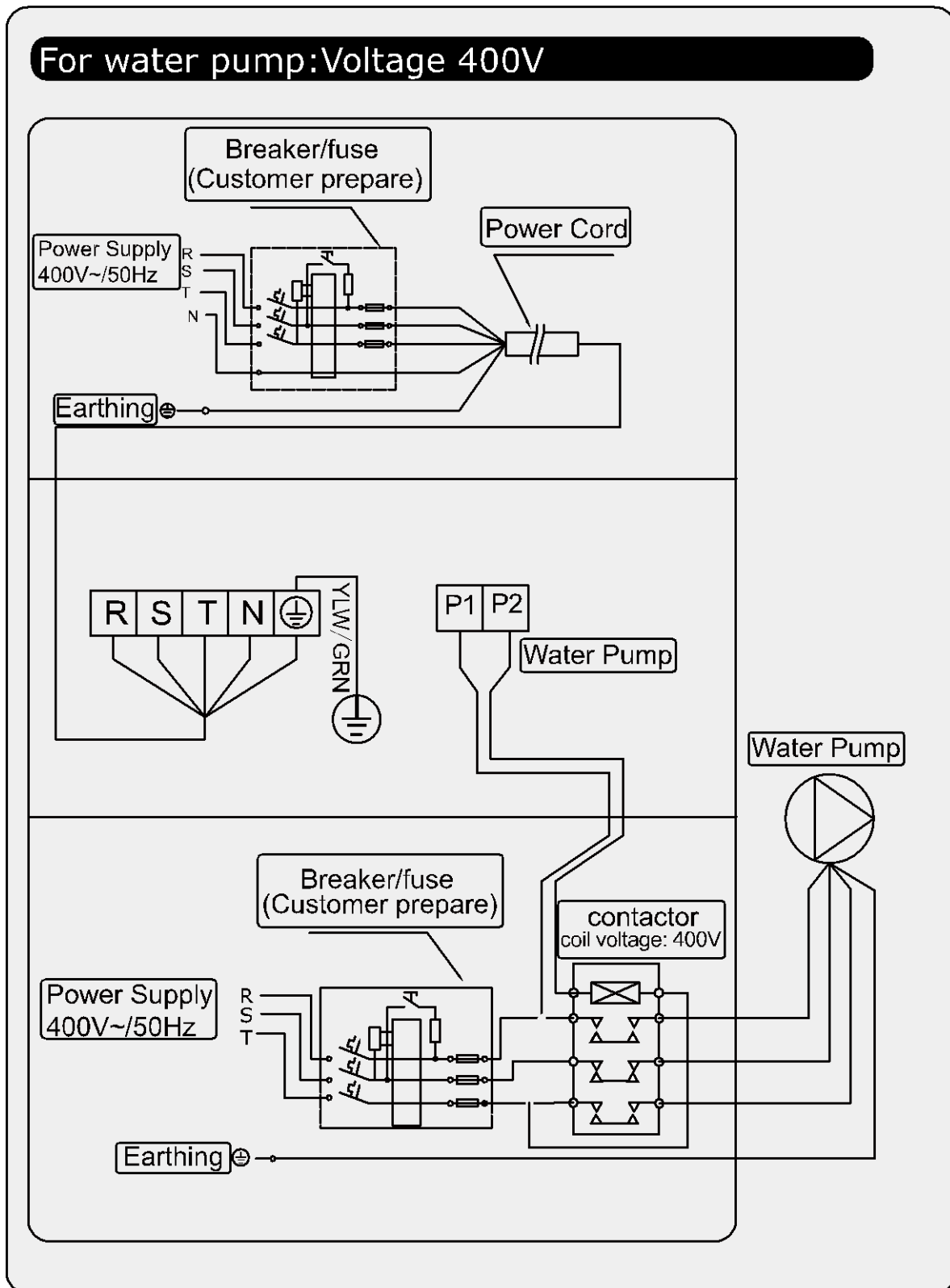

Parallel connection with filtration clock

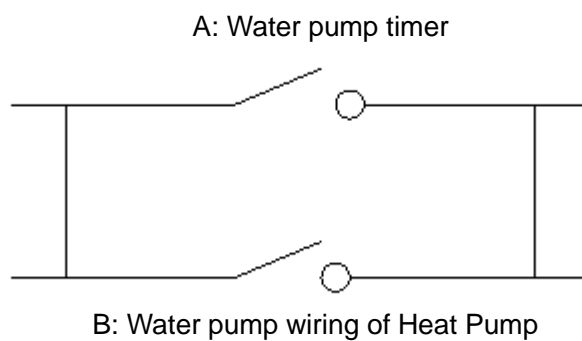

Note: The installer should connect A parallel with B (as above picture). To start the water pump, condition A or B is connected. To stop the water pump, both A and B should be disconnected.

5. WIFI SETTING

1) APP Download

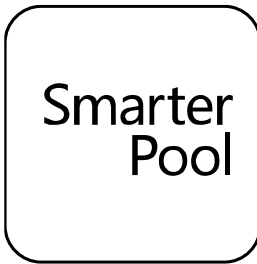

Android mobile please download from



iphone please download from



2) Account registration

a) Registration by Cell phone number/Email

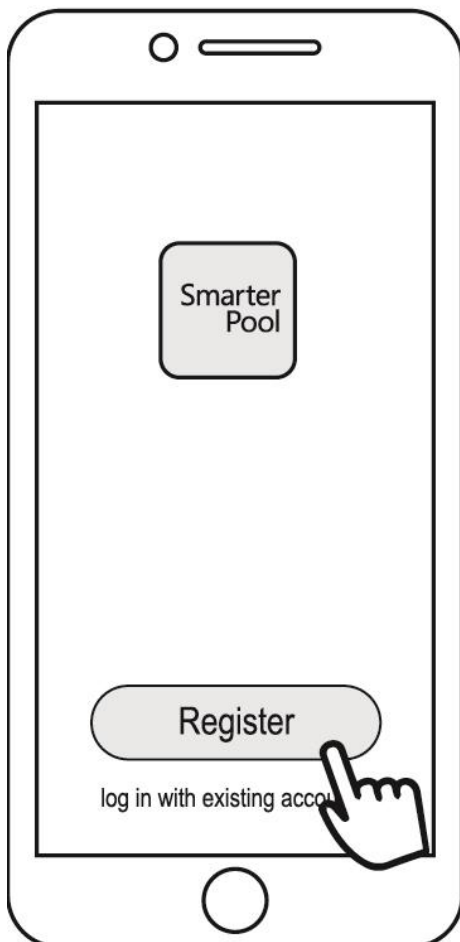

b) Cell phone number registration

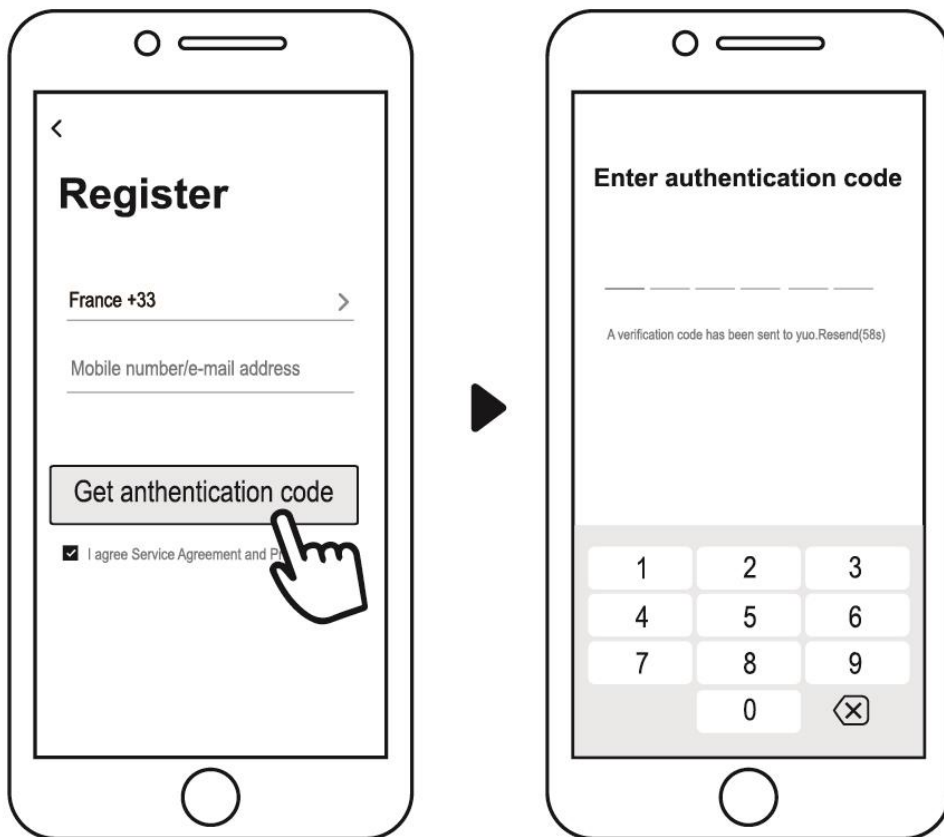

3) Create family

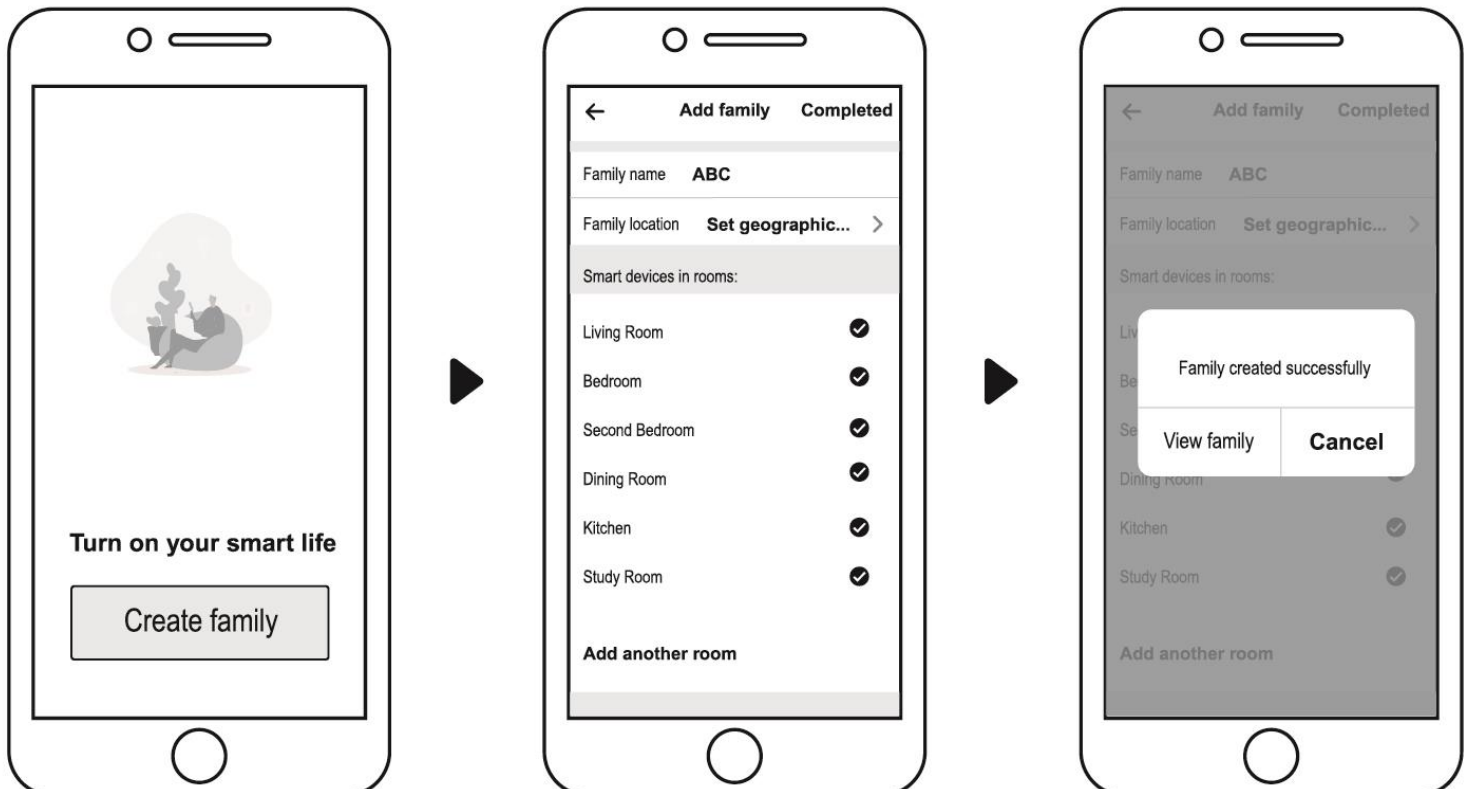

Please set family name and choose the room of device



4) APP Binding

Please make sure your cell phone has connected the Wifi

a) Wifi connection:

Press  for 3 seconds after screen unlock,  will be flashing to enter Wifi binding program.





b) Click "Add device", follow indication to finish binding.  display on the screen once Wifi connection success.



c) If connect fails, please make sure your network name and password is correct. And your router, mobile phone and device are as close as possible.

d) Wifi rebinding (When Wifi password changes or network configuration changes):

Press  for 10 seconds,  will be flashing slowly for 60 seconds. Then  will be off. The original binding will be removed. Follow step above for rebinding.

Remarks: Please make sure the router is configured at 2.4G.

5) Operation

For heat pump with Heating function only.

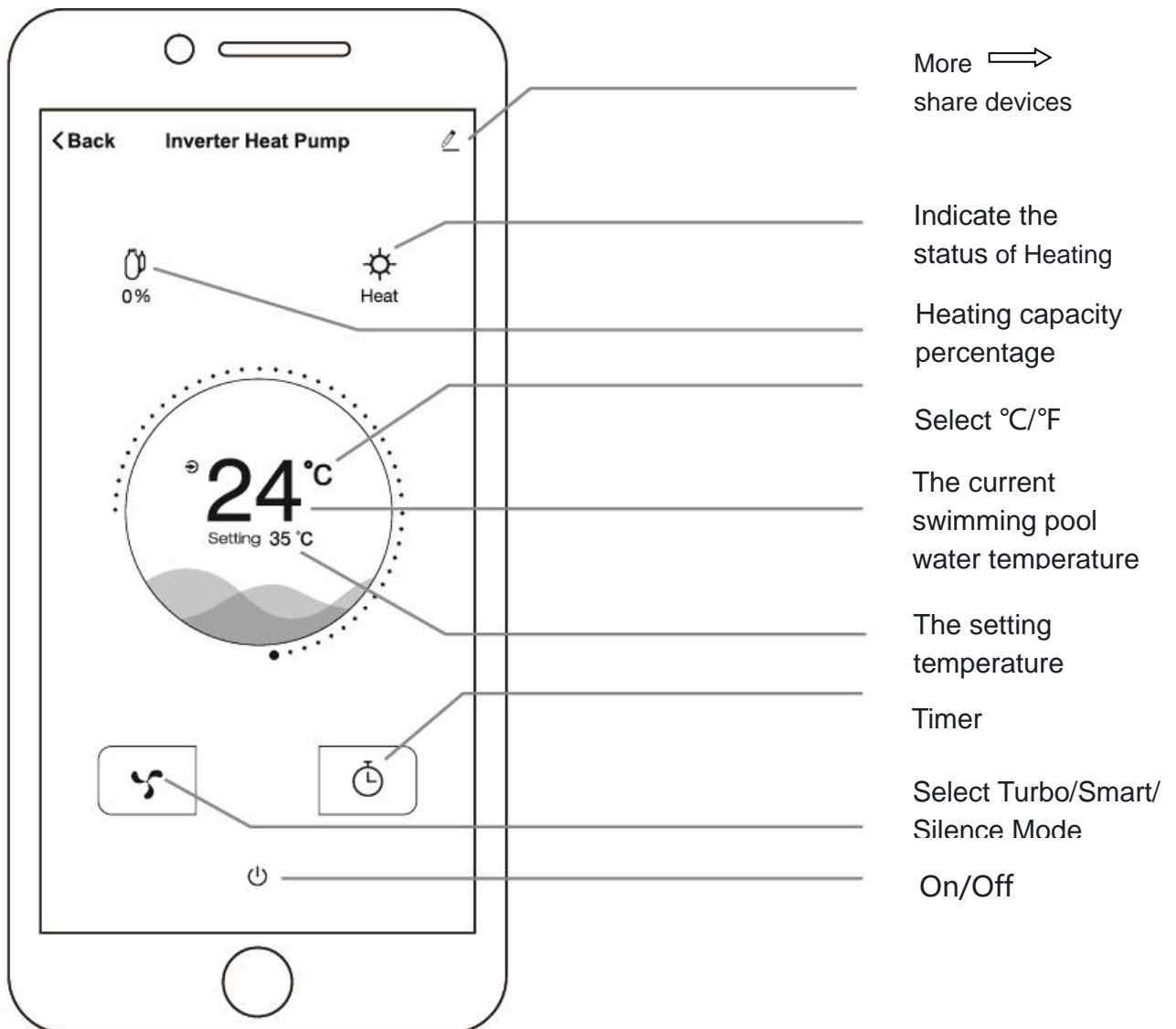

6) Share devices to your family members

After binding, if your family members also want to control the device.

Please let your family members register the APP first, and then the administrator can operate as below:

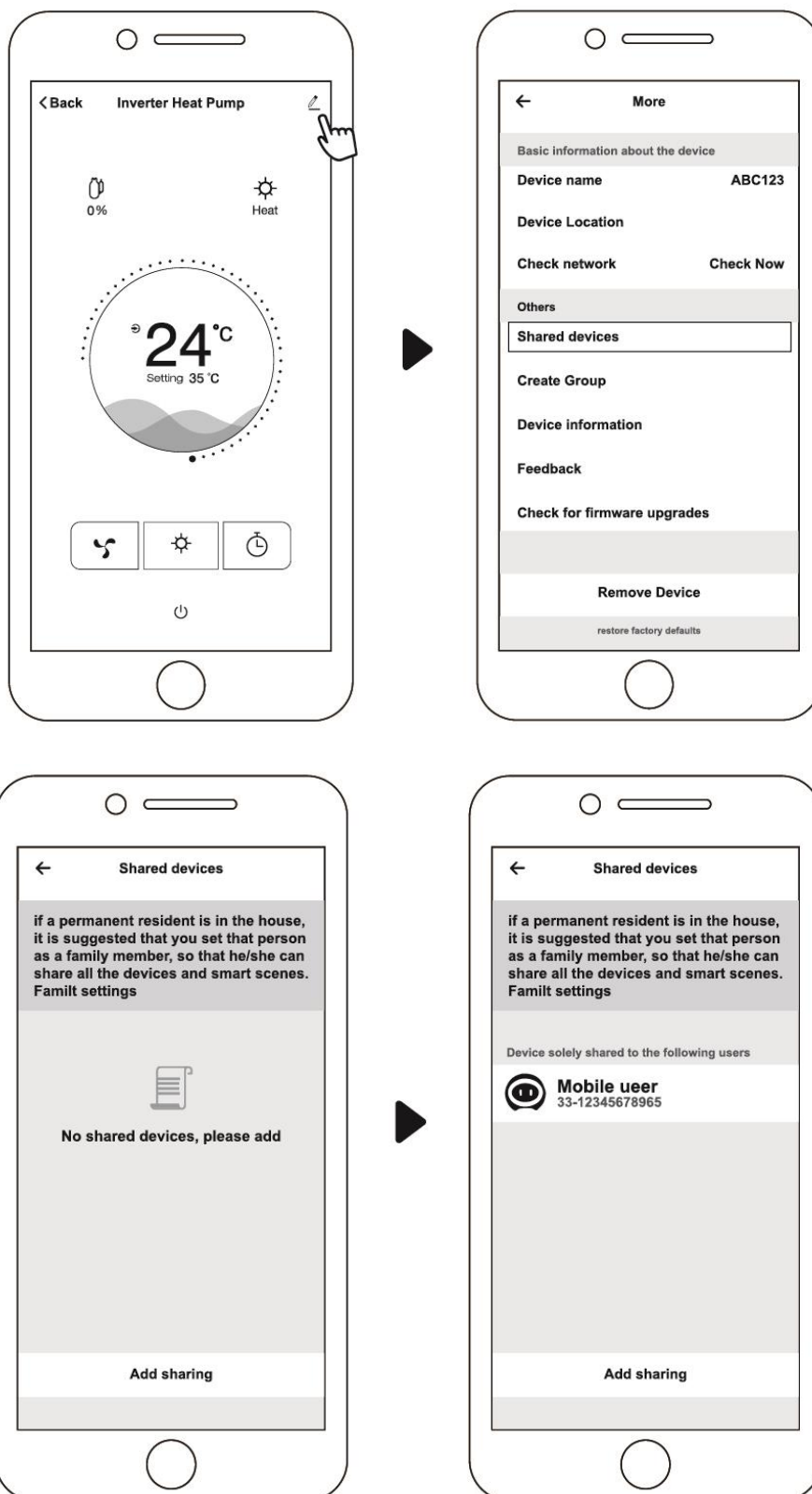

Then your family members can log in as below:



Notice: 1. The weather forecast is just for reference.

2. APP is subject to updating without notice.

welldana®



Version: D00XVr32