

ASIN Salt

2021

ELECTROLYSER FOR DISINFECTION
OF THE SWIMMING POOL WATER



Electrode TE-25

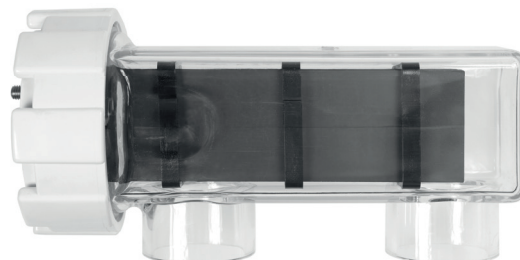



General safety information

This user manual contains basic information that should be observed during assembly, start-up, operation, and maintenance. Therefore, this user manual must be read by installers and operators prior to assembly and start-up, and must be accessible to every user of this unit. Additionally, all further safety information in this document absolutely must be observed. Read and follow all instructions. In order to minimize the danger of injury, do not allow children to use this product. Hazards from non-compliance with safety information. Non-compliance with safety information can result in hazards to persons, the environment, and the equipment. Non-compliance with safety information will result in a forfeit of any potential right to damage compensation.

Insufficient personnel qualification

Hazards in the event of insufficiently qualified personnel, potential consequence: Injury, heavy material damage.

- The system operator must ensure compliance with the required qualification level.
- Any and all work may only be performed by correspondingly qualified personnel.
- Access to the system must be prevented for insufficiently qualified persons, e.g. via access codes and passwords.

Potential overdosing of chemical agents

Despite ASIN Aqua® comprehensive safety functions, it is possible that a probe failure and other errors could lead to an overdosing of chemical agents. Potential consequence: Injury, heavy material damage.

- Design your installation such that uncontrolled dosage is not possible in the event of a probe failure or other errors, and/or such that uncontrolled dosage is recognized and halted before damage is incurred.
- Uncontrolled overdose of chemicals can cause harm to health and property. Even though the device contains a number of security elements can not be ruled out that in case of failure of the measuring probes, or the whole device may result in overdose of chemical agents. Install the equipment so that uncontrolled overdose of chemicals was not possible and that uncontrolled overdose has been detected in time before causing any harm. It is necessary to use chemicals in such quantities that an overdose will not cause dangerous concentration of chemical agents. Do not use chemicals in too large packages or with too high concentration.

Gaseous chlorine produced from dosing in standing water if dosing outputs are not closed via the filter pump

If the flow switch is stuck or experiences another error, there is a risk of dosing into standing water. Poisonous chlorine gas can be yielded when sodium hypochlorite and pH minus come together.

Non compliance with informational text

There is a great deal of informational text indicating hazards and their avoidance. Not observing informational text may lead to hazards. Potential consequence: gravest degree of injury, heavy material damage.

- Read all informational text carefully.
- Cancel the process if you are unable to exclude all potential hazards.

Use of new functions

Because of the continued development, a ASIN Aqua® unit may contain functions, which are not completely described in this version of the user manual. The use of such new or extended functions without a profound and secure understanding by the operator may result in malfunctions and severe problems. Potential consequence: Injury, heavy material damage.

- Make sure to get a profound and secure understanding of a function and relevant boundary conditions, before you start to use it.
- Check for an updated version of the user manual or additional documentation available for the relevant functions.
- Make use of the integrated help function of the ASIN Aqua® to get detailed information on functions and their parameter settings.
- In case it should not be possible to get a profound and secure understanding of a function based on the available documentation, do not use this function.

Overdosing if pH value is wrong

If disinfection is enabled before the pH value is stable in the ideal range of 7.0 to 7.4, then it may lead to heavy overdosing of chlorine or bromine. Potential consequence: Injury, heavy material damage.

- Do not start disinfection with chlorine until the pH value is stable in the ideal range between 7.0 and 7.4.

Conditions before using

Make sure you have a newest and updated version of the user manual and other documentation for all functions of the unit. Use and read the integrated help features. In case of not understanding the information about certain features of the unit, do not use these features.

Handling chemicals for pool water treatment

The chemicals used with the ASIN Aqua must be handled in a safe manner to prevent damage or personal harm. Aseko recommends you always use personal protective safety equipment when handling the pH and chlorine agents. Refer to the Materials Safety Data Sheet (MSDS).

WARNING: Never mix the pH agent with the chlorine agent. When carrying out maintenance on the clear plastic tubes or valves always rinse with clean water to prevent mixing of the pH and chlorine agents.



What do you receive in your box

Device
ASIN Salt



Electrode TE-25



Flowmeter with filter
#12106



Water valves 2 pcs #12006



PE Tube 1/4"(6.35 mm)
transparent 10m #12008



Dowels
and screws



Sharp knife for cutting
of interconnecting hose



Available optional accessories

Inserting plug DN50
1/4" threaded #12134



Biocid certified Salt
#12110



ASIN Salt



The ASIN Salt is a microprocessor-controlled electrolysis device. Salt water is electrolyzed by the modern system under the chlorine production, which ensures the complete disinfection of the water and destroys bacteria, viruses and green algae. During the electrolysis, the salt NaCl (4 kg / m³) contained in the water is broken down with the formation of chlorine, which remains in the water in the form of hypochlorous acid. ASIN Salt consists of the electrolysis cell and the ASIN Salt control unit, which:

- Enables the setting of the power in the range 10 - 100% (time control).
- Detects the overload of the electrolytic cell.
- Measures the salinity in the water.
- Shows the performance of the electrolyzer in g CL/hour.
- The self-cleaning of the electrolysis cell is ensured by switching.

MAX POOL VOLUME
60 – 90 m³



Electrode TE-25

TE25 is a state-of-the-art electrolysis cell. The titanium construction with ruthenium-iridium surface has a long service life and high performance. The transparent housing is made of highly resistant ABS.

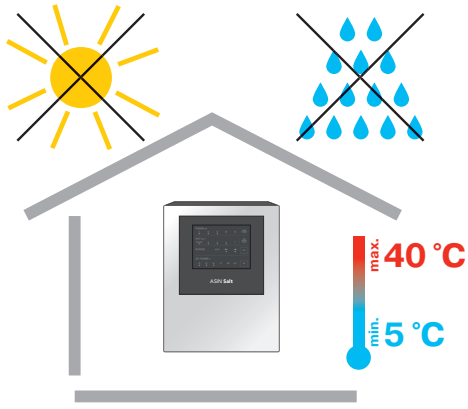

Installation of ASIN Salt

ASIN Salt is mounted on the wall in a dry and dust-free environment with a temperature that does not fall below +5 °C and does not exceed +40 °C. A mounting strip that is to be mounted on the wall is used for fastening.

Direct sunlight, high humidity and dust can damage ASIN Salt.

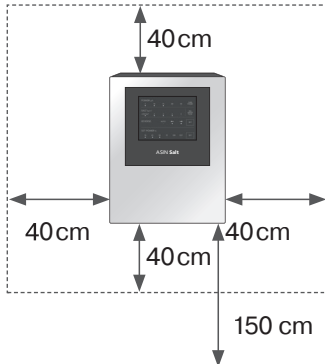

Wall bracket

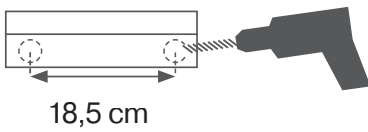

Electrode TE-25



Assembly of the Electrode TE-25

The Electrode TE-25 is installed on the outlet water pipeline from the filtration in the swimming pool. Assembly is carried out in the direct part of the pipe $d = 50$ by gluing. The kit for gluing is not included.

Salinity measuring unit

The salt content sensor is part of the sample water filter.



Flowmeter with filter and salinity measurement



Salinity sensor
is now in
the filter

Max 1,5 m

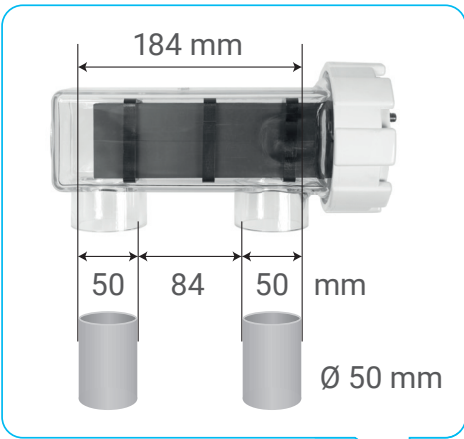
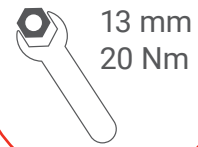

Gluing

Besgo

FROM POOL

TO POOL

Heating

Pool Water Connection

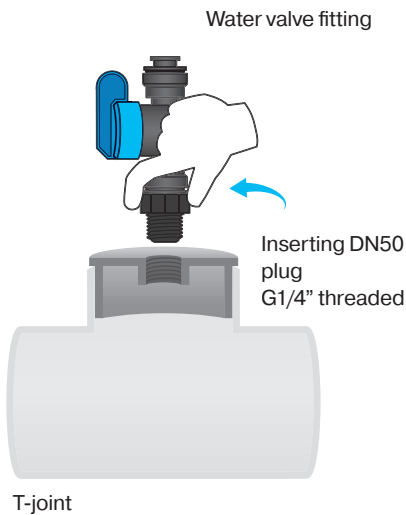
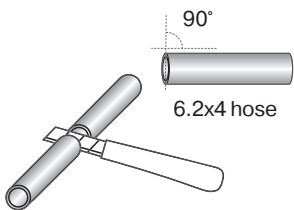
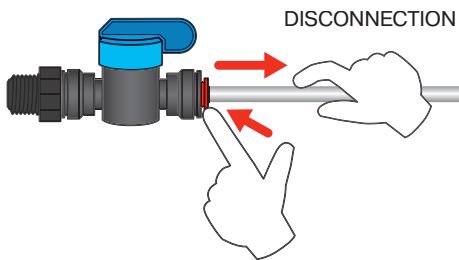
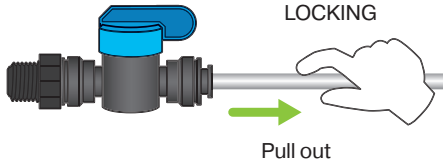
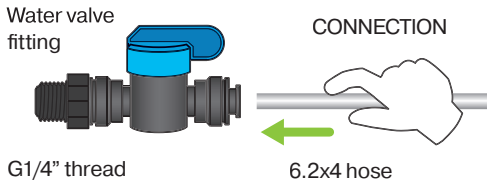

The pool water to be measured must be connected to ASIN Salt. Connect the measured water inlet downstream of the pump, upstream of the filter. Place the water valve fitting to the T-joint, blinded by DN50 G1/4" threaded plug #12134.

- The connecting fitting is installed in G1/4" thread.

Aseko provides the unique Speedfit connecting fitting for measured water connection to your ASIN Salt. To connect the interconnecting tube, push it into the Speedfit connector and then lock it by pulling back. To disconnect the interconnecting tube, push and hold a circular collet and pull the interconnecting tube out.

WARNING: To treat PE tube ends, use a sharp knife (part of delivery). The use of scissors or tongs deforms the tube end and leads to leaks.

WARNING: Only hand tighten. Do not use tongs or any other tools.

1. To ensure tightness of joints, cut the tube at 90° angle.
 - Use the sharp knife to cut plastic. The cut must be clean and smooth.
2. Connect the water inlet to the measured water filter connection and the water outlet to the probe housing connection. Make sure that measured water pressure does not exceed 1.5 bar.
3. The water outlet can be realized:
 1. downstream of filtration
 2. to non-pressure (overflow tank)
 3. upstream of filter pump

When the electrode is in bypass is installed (which we recommend), either the sample water extraction or the sample water return must also be installed in the bypass.

This ensures that the electrode only receives electricity when when there is water flow.

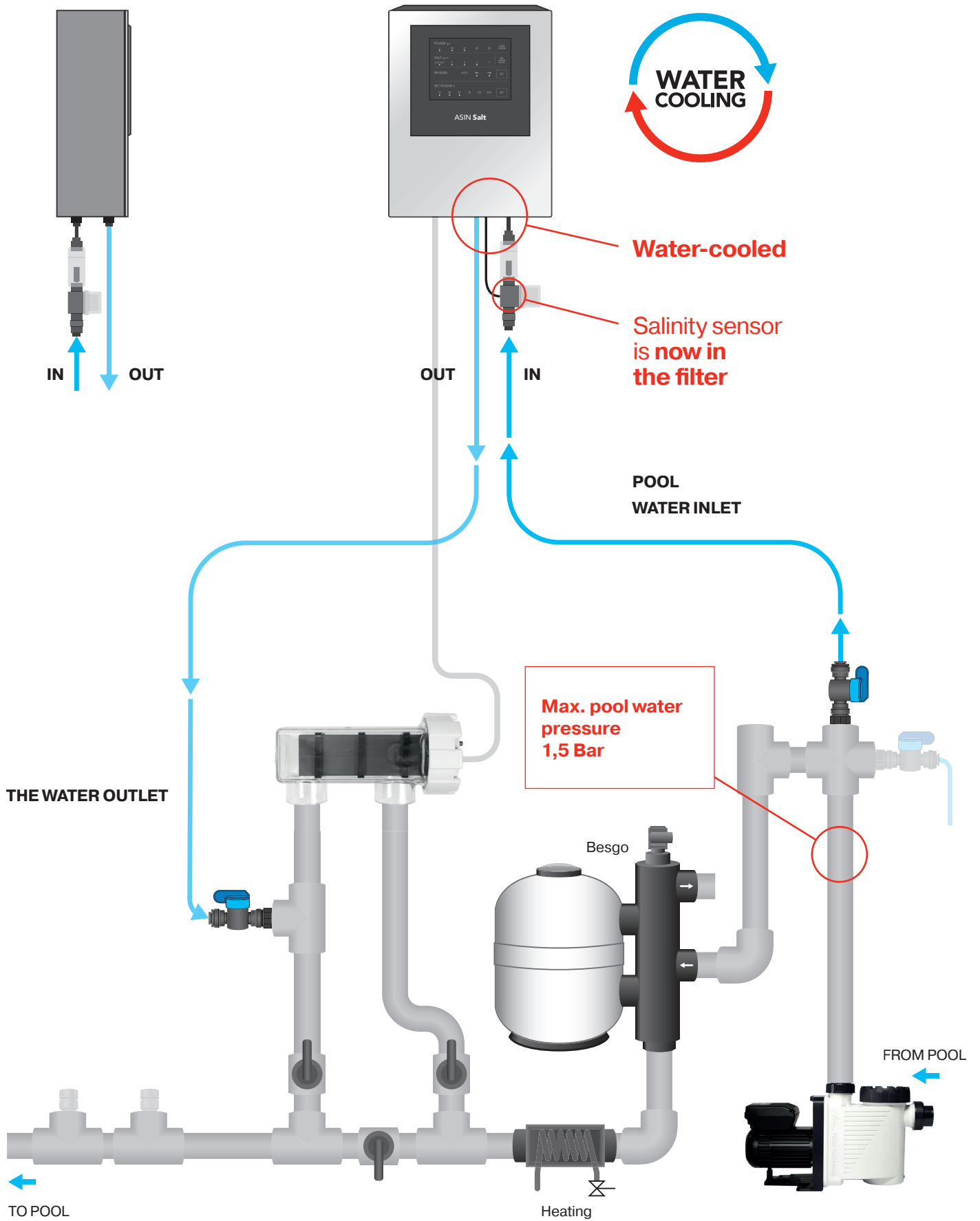

Connection of the ASIN Salt to increase performance

The ASIN Salt extension module must be connected to the ASIN AQUA Salt control unit with a cable. To the external control too activate, select the EXT mode on the led display.



Connection cable to ASIN Salt

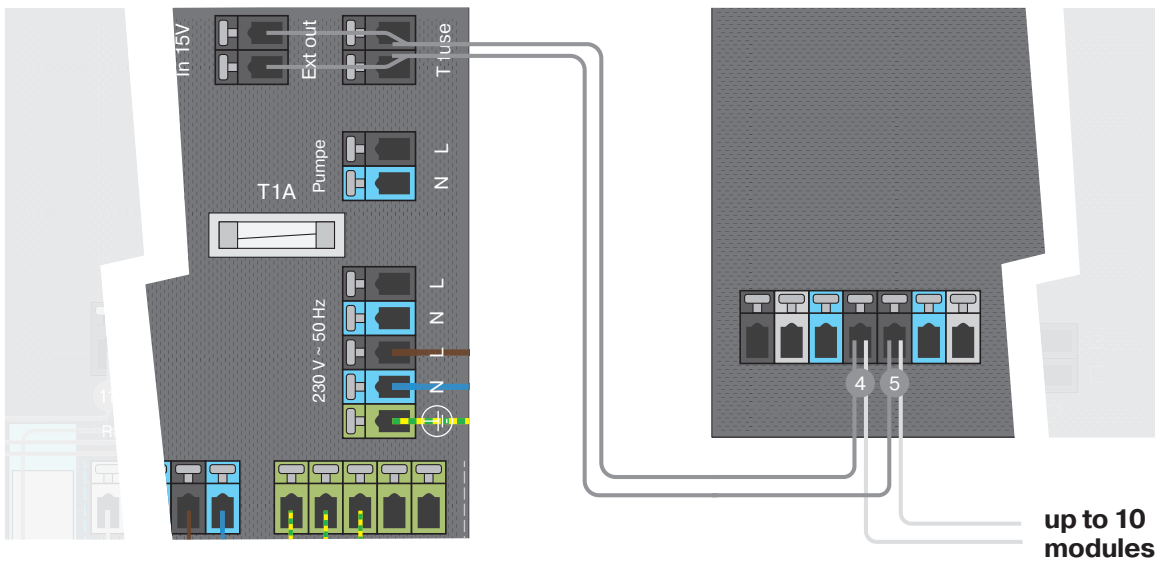

Select the EXT mode



up to 10 modules

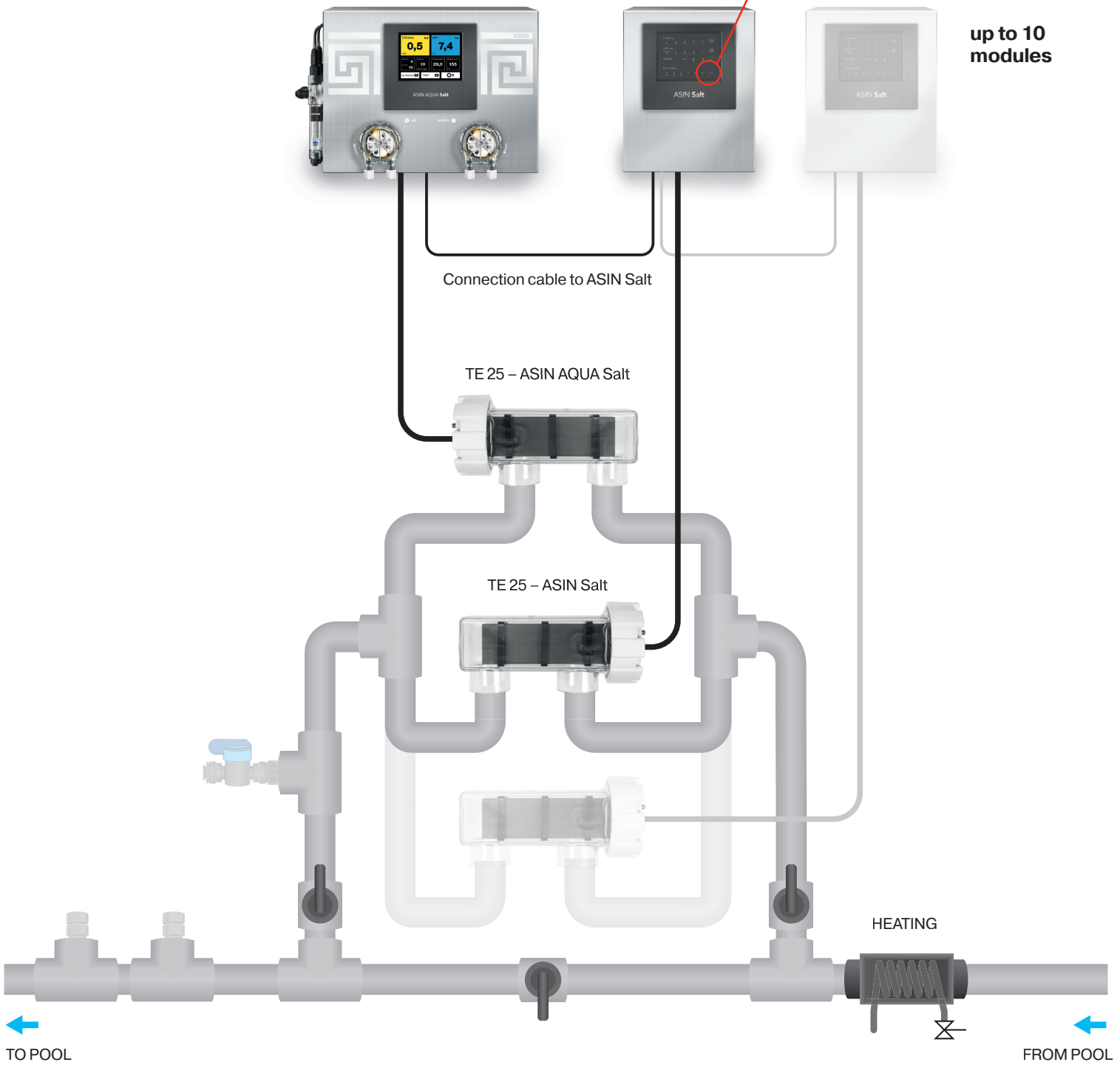



Installation must be protected by a residual current device (RCD).

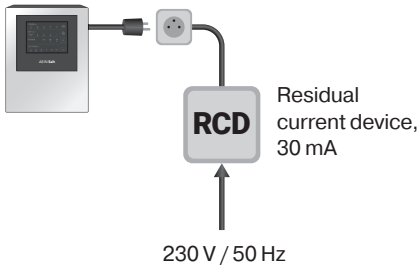

Power Supply

Connection to the mains:

1. Leave the mains switch in the off position.
2. Connect the 230 V / 50 Hz mains cable to ASIN Salt. The mains socket outlet must be protected by a residual current device (RCD).
3. Change the mains switch over to the on position.

After Device has been switched on, the display will come on and the ASIN Salt.

Disconnection from the mains:

1. Change the mains switch over to the off position.
2. Disconnect the ASIN Salt mains cable from the 230 V / 50 Hz socket outlet.

WARNING: If Device is used in the manner different from that specified by the manufacturer, protection provided by Device may get damaged.

Power supply	230 V AC 50 Hz
Power consumption	157 W
Unit fuse	T2A
Electronics fuse	T125 mA
Protection class	IP30
Overvoltage category	II
Operation temperature	+5 to +40°C
Max. measuring water pressure	1,5 bar
Dimensions	240 x 330 x 150 mm
Weight	5,5 Kg

Operation



- POWER g/h power
- SALT kg/m³ salinity
- REVERSE polarity reverse
- SET POWER power settings

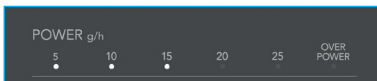

POWER g/h

It shows how many grams of chlorine ASIN Salt produces per hour. When the ASIN salt is overloaded, the OVER POWER LED flashes red.



SALT kg/m³

Shows the salinity in kg per m³ of water. The red LOW SALT LED flashes for values below 1.5 kg/m³. If the water flow is low, the NO WATER FLOW LED flashes red.



REVERSE

Indicates and adjusts the direction of electrical current flow through the electrodes. The auto mode changes the direction of the current flow automatically after 1 hour. This mode is suitable for water with a higher hardness. A longer service life of the electrode can be achieved by lengthening the reversal time, so that one of the two current flow directions can also be permanently set. This mode is only suitable for waters with a low mineral content.

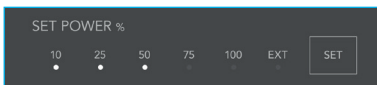

SET POWER %

Set the required power to 10, 25, 50, 75 and 100% of the current power. The performance is regulated by shortening the production time.

In EXT mode, ASIN Salt is used as an extension of the ASIN AQUA Salt, power is regulated according to the measurements.

MAX POOL VOLUME

Uncovered
60 m³

Covered
90 m³

Max. Salt
4 kg/m³

Min. Salt
1,5 kg/m³

RECOMMENDED WATER PARAMETERS

Salt concentration

1,5 - 4 kg/m³

1,5 - 4 ppm

pH

7,2 - 7,6

Alkalinity

80 - 150 ppm

Calcium hardness

Max 250 ppm

max. 14 dH

System start-up

Salting the pool water

Chlorine generating depends on the salt concentration and water temperature. As lower the temperature as lower the chlorine production. You can boost the electrolyzer by increasing the salt concentration. 1 kg of salt per cubic meter of water can increase the electrolysis power for about 20%. Maximum salt quantity is 4kg/m³.

Exceeding of the recommended salt concentration will overload power supply components of the ASIN AQUA Salt. The main unit is protected by maximum current control circuit. At overload is the power supply automatically disconnected. Then the salt concentration before switching the power supply again. Never use lower salt concentration than 3g/l - this expressively reduce the electrode lifetime. Higher salt concentration is very corrosive and may cause corrosion of pool equipment.

Disinfection is expressively affected by following:

- temperature
- intensity of sun shining
- quantity of person using the pool
- weather conditions
- organic pollution

Instructions to operate the electrolyzer:

Never switch on the ASIN AQUA Salt before the salt concentration in the pool water reach at least 3g/l. This may cause the electrode damage. Optimum concentration is 4g/l.

Quantity of produced disinfection by ASIN AQUA Salt is controlled by salt concentration, time of ASIN AQUA Salt operation.

Never switch on the ASIN AQUA Salt before dissolving of all salt.

Electrode connection to ASIN AQUA Salt must be done only when disconnected power supply.

SALT

BIOCID CERTIFIED

Salt to be used

Do not use rock salt. All additives may cause electrode lifetime shortening.

ASIN AQUA Salt is designed to electrolyze water with 4 kg/m³ salt concentration.

Electrode may get damaged at lower salt concentrations than 3 kg/m³. It is necessary to provide routine salt concentration control. The salt concentration is getting changed by the electrolyzer operation just minimally.

The main concentration waste is caused by filter backwashing, splashing and strong rains (in case of outdoor pool).

Following sheet describe salt quantity in kg necessary to increase the concentration to 4 kg/m³.

SALT CONTENT kg/m ³	POOL VOLUME									
	10 m ³	15 m ³	20 m ³	25 m ³	30 m ³	35 m ³	40 m ³	50 m ³	60 m ³	70 m ³
	Salt quantity in kg, necessary to increase the concentration to 4 kg/m ³									
0	40	60	80	100	120	140	160	200	240	280
0,25	37,5	56,25	75	93,75	112,5	131,25	150	187,5	225	262,5
0,5	35	52,5	70	87,5	105	122,5	140	175	210	245
0,75	32,5	48,75	65	81,25	97,5	113,75	130	162,5	195	227,5
1	30	45	60	75	90	105	120	150	180	210
1,25	27,5	41,25	55	68,75	82,5	96,25	110	137,5	165	192,5
1,5	25	37,5	50	62,5	75	87,5	100	125	150	175
1,75	22,5	33,75	45	56,25	67,5	78,75	90	112,5	135	157,5
2	20	30	40	50	60	70	80	100	120	140
2,25	17,5	26,25	35	43,75	52,5	61,25	70	87,5	105	122,5
2,5	15	22,5	30	37,5	45	52,5	60	75	90	105
2,75	12,5	18,75	25	31,25	37,5	43,75	50	62,5	75	87,5
3	10	15	20	25	30	35	40	50	60	70
3,25	7,5	11,25	15	18,75	22,5	26,25	30	37,5	45	52,5
3,5	5	7,5	10	12,5	15	17,5	20	25	30	35
3,75	2,5	3,75	5	6,25	7,5	8,75	10	12,5	15	17,5
4	0	0	0	0	0	0	0	0	0	0

Maintenance

Flowmeter with filter and salinity measurement #13264



To ensure optimal performance, the ASIN Salt requires regular visual inspection and maintenance.

Flowmeter with filter and salinity measurement

Rinse the sieve of the flow monitor regularly.

Elektrolysezelle TE – 25



Durability of the electrolytic cell

Lifetime of the electrolytic cell is 8000 running hours. The electrodes in the electrolytic cell are made of titanium with a ruthenium and iridium layer. During electrolysis this layer gets consumed. Durability of the electrodes is reduced by the following parameters:

- Low salt content
- Water temperature below 10 ° C
- Low water flow
- Too hard water
- pH below 7.5
- Addition of metals containing preparations

Electrolysis cell cleaning

Electrolysis cell cleaning

In operation, the electrolysis cell is gradually clogged by sediments from the hard water, that must be eliminated repeatedly. The clogging of the electrolysis cell decreases the electrolysis cell capacity. In this case, the electrolysis cell has to be taken out and submerged in the cleaning bath for about 10 minutes. The coating should disappear and the electrolysis cell can be used again.

welldana®

aseko

USER MANUAL

ASIN Salt

EN